

JVC®



ENGLISH

VIDEO CASSETTE RECORDER

HR-S5600AM



G-CODE™ / SHOWVIEW™ *Hi-Fi* **S-VHS** *Super VHS ET*
525/625

INSTRUCTIONS

CONTENTS

SAFETY FIRST	2
Safety Precautions	2
INSTALLING YOUR NEW RECORDER 4	
Basic Connections	4
S-VIDEO Connection	5
INITIAL SETTINGS	6
Video Channel Set	6
Auto Set Up	8
On-Screen Displays	10
Select Language	11
Clock Set	12
PLAYBACK	13
Basic Playback	13
Playback Features	14
RECORDING	17
Basic Recording	17
Recording Features	18
B.E.S.T. Picture System	22
TIMER RECORDING	24
G-CODE System Setup	24
G-CODE Timer Programming	26
Express Timer Programming	28
SPECIAL FEATURES	32
Remote Control Functions	32
SYSTEM CONNECTIONS	34
Connecting/Using A Stereo System	34
EDITING	35
Preparation For Editing	35
Edit From A Camcorder	36
Edit To Or From Another Video Recorder	37
Audio Dubbing	38
INFORMATION ON MULTI-SYSTEM COMPATIBILITY	40
TUNER SET	42
TROUBLESHOOTING	46
QUESTIONS AND ANSWERS	49
INDEX	50
SPECIFICATIONS	53

EN

LPT0306-001B

Safety Precautions

The rating plate and the safety caution are on the rear of the unit.

WARNING: DANGEROUS VOLTAGE INSIDE

WARNING: TO PREVENT FIRE OR SHOCK HAZARD, DO NOT EXPOSE THIS UNIT TO RAIN OR MOISTURE.

CAUTION

- When you are not using the recorder for a long period of time, it is recommended that you disconnect the power cord from the mains outlet.
- Dangerous voltage inside. Refer internal servicing to qualified service personnel. To prevent electric shock or fire hazard, remove the power cord from the mains outlet prior to connecting or disconnecting any signal lead or aerial.
- Use the conversion plug (not provided in certain areas) depending on the type of your AC wall outlet.

ATTENTION

1. This recorder can also receive SECAM colour television signals for recording and playback.
2. Recordings made of SECAM television signals produce monochrome pictures if played back on another video recorder of SECAM standard, or do not produce normal colour pictures if played back on another video recorder of PAL standard.
3. SECAM prerecorded cassettes or recordings made with a SECAM video recorder produce monochrome pictures when played back with this recorder.

IMPORTANT

- Please read the various precautions on this page before installing or operating the recorder.
- It should be noted that it may be unlawful to re-record pre-recorded tapes, records, or discs without the consent of the owner of copyright in the sound or video recording, broadcast or cable programme and in any literary, dramatic, musical, or artistic work embodied therein.

Warning on lithium battery

The battery used in this device may present a fire or chemical burn hazard if mistreated. Do not recharge, disassemble, heat above 100°C or incinerate.

Replace battery with Panasonic (Matsushita Electric), Sanyo, Sony or Maxell CR2025; use of another battery may present a risk of fire or explosion.

- Dispose of used battery promptly.
- Keep away from children.
- Do not disassemble and do not dispose of in fire.



- Cassettes marked "S-VHS" and "VHS" can be used with this video cassette recorder. However, S-VHS recordings are possible only with cassettes marked "S-VHS".

By using S-VHS ET it is possible to record and play back with S-VHS picture quality on VHS cassettes with this recorder.

- G-CODE and SHOWVIEW are trademarks of Gemstar Development Corporation.
The G-CODE/SHOWVIEW system is manufactured under license from Gemstar Development Corporation.

POWER SYSTEM

This set operates on voltage of AC110 – 240 V \sim (Rating), AC90 – 260 V \sim (Operating), 50/60 Hz with automatic switching.

The STANDBY/ON ϕ /I button does not completely shut off mains power from the unit, but switches operating current on and off. " ϕ " shows electrical power standby and " I " shows ON.

Video tapes recorded with this video recorder in the LP (Long Play) or EP (Extended Play) mode cannot be played back on a single-speed video recorder.

Failure to heed the following precautions may result in damage to the recorder, remote control or video cassette.

1. **DO NOT place the recorder . . .**
 - ... in an environment prone to extreme temperatures or humidity.
 - ... in direct sunlight.
 - ... in a dusty environment.
 - ... in an environment where strong magnetic fields are generated.
 - ... on a surface that is unstable or subject to vibration.
2. **DO NOT block the recorder's ventilation openings.**
3. **DO NOT place heavy objects on the recorder or remote control.**
4. **DO NOT place anything which might spill on top of the recorder or remote control.**
5. **AVOID violent shocks to the recorder during transport.**

MOISTURE CONDENSATION

Moisture in the air will condense on the recorder when you move it from a cold place to a warm place, or under extremely humid conditions—just as water droplets form in the surface of a glass filled with cold liquid. Moisture condensation on the head drum will cause damage to the tape. In conditions where condensation may occur, keep the recorder turned on for a few hours to let the moisture dry.

ABOUT HEAD CLEANING

Accumulation of dirt and other particles on the video heads may cause the playback picture to become blurred or interrupted. Be sure to contact your nearest JVC dealer if such troubles occur.

Auto Head Cleaner

A built-in head cleaner automatically cleans the video heads and head drum whenever a tape is loaded or unloaded to reduce head clogging.

Basic Connections

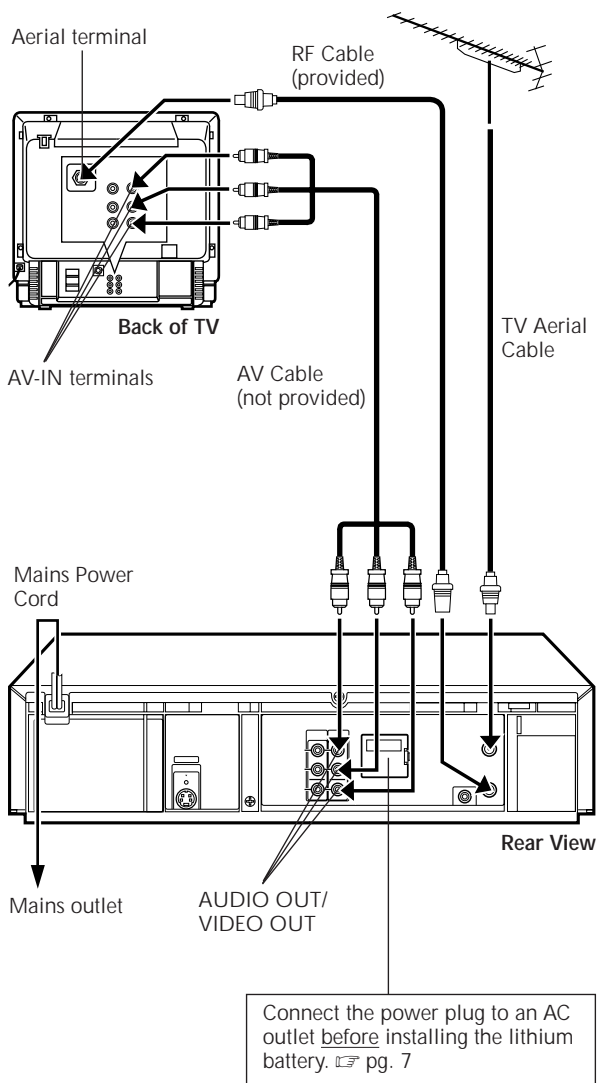

It's essential that your video recorder be properly connected. Follow these steps carefully. THESE STEPS MUST BE COMPLETED BEFORE ANY VIDEO OPERATION CAN BE PERFORMED.

1

CHECK CONTENTS

Make sure the package contains all of the accessories listed in "SPECIFICATIONS" (pg. 53).

2

SITUATE RECORDER

Place the recorder on a stable, horizontal surface.

3

CONNECT RECORDER TO TV

The connection method you use depends on the type of TV you have.

RF CONNECTION

- To Connect To A TV With NO AV Input Terminals . . .
 - a- Disconnect the TV aerial cable from the TV.
 - b- Connect the TV aerial cable to the ANT. IN jack on the rear panel of the recorder.
 - c- Connect the provided RF cable between the RF OUT jack on the rear panel of the recorder and the TV's aerial terminal.

AV CONNECTION

- To Connect To A TV With AV Input Terminals . . .
 - a- Connect the aerial, recorder and TV as per "RF CONNECTION".
 - b- Connect an optional AV cable between the AUDIO OUT and VIDEO OUT connectors on the rear panel of the recorder and the TV's AV-IN terminals .

4

CONNECT RECORDER TO MAINS

Plug the end of the mains power cord into a mains outlet.

NOTE:

Use the conversion plug (not provided in certain areas) depending on the type of your AC wall outlet.

ATTENTION

If you have finished all the necessary connections, go to "Video Channel Set" on page 6, then perform Auto Set Up on page 8; do NOT press the $\Psi/1$ button on the recorder/remote control to turn on the recorder's power before you start Auto Set Up.

S-VIDEO Connection

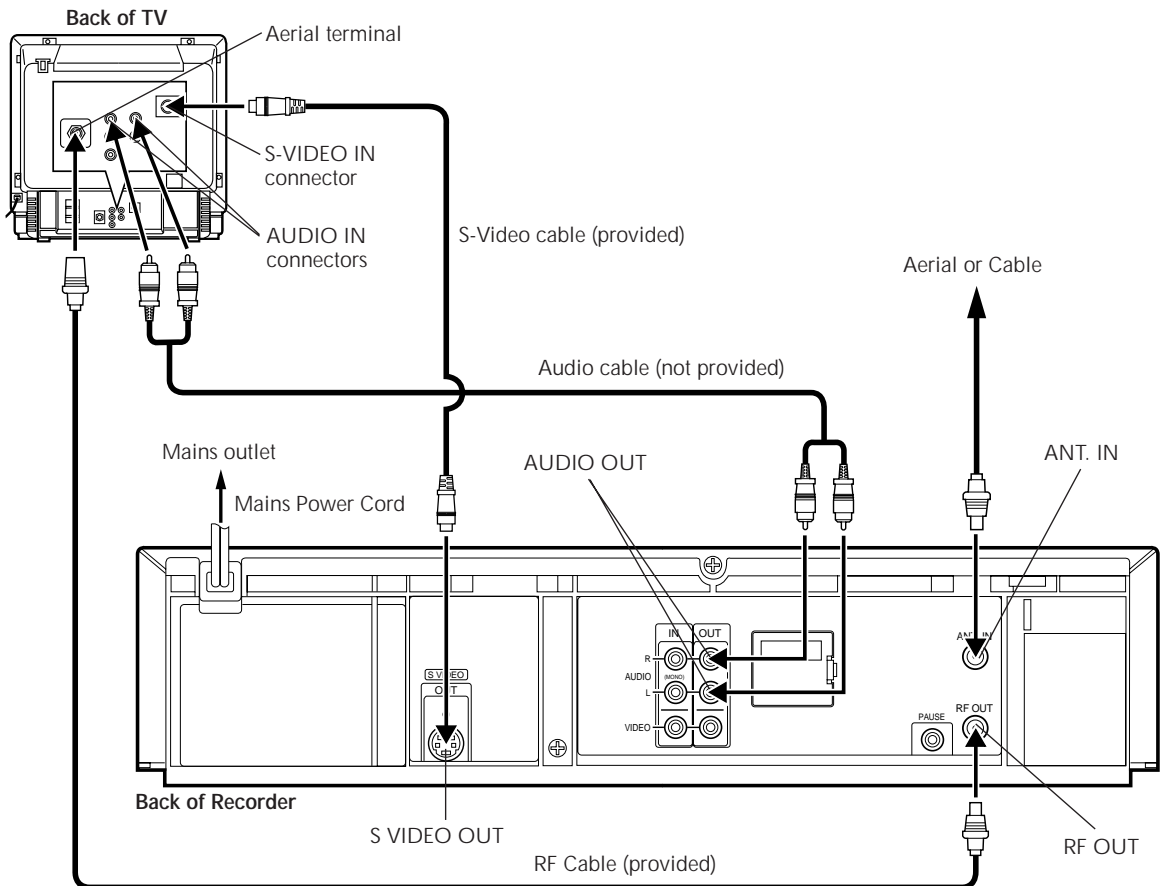

- To Connect to A TV With S-VIDEO/AUDIO IN Connectors . . .

1 CONNECT RECORDER TO TV

- Connect the aerial, recorder and TV as per "RF CONNECTION" (☞ pg. 4).
- Connect the recorder's S VIDEO OUT connector to the TV's S-VIDEO IN connector.
- Connect the recorder's AUDIO OUT connectors to the TV's AUDIO IN connectors.

2 CONNECT RECORDER TO MAINS

- Plug the end of the mains power cord into a mains outlet.

NOTES:

- You can obtain high-quality S-VHS pictures.
- If your television is not stereo-capable, use the recorder's AUDIO OUT connectors to connect to an audio amplifier for Hi-Fi stereo sound reproduction. (☞ pg. 34)
- To operate the recorder with your TV using the S-VIDEO connection, set your TV to the VIDEO (or AV mode).
- For switching the TV's mode, refer to the instruction manual of your television.

ATTENTION

If you have finished all the necessary connections, go to "Video Channel Set" on page 6, then perform Auto Set Up on page 8; do NOT press the button on the recorder/remote control to turn on the recorder's power before you start Auto Set Up.

Video Channel Set

Video Channel (RF Output Channel) is the channel on which your TV receives picture and sound signals from the video recorder through the RF cable.

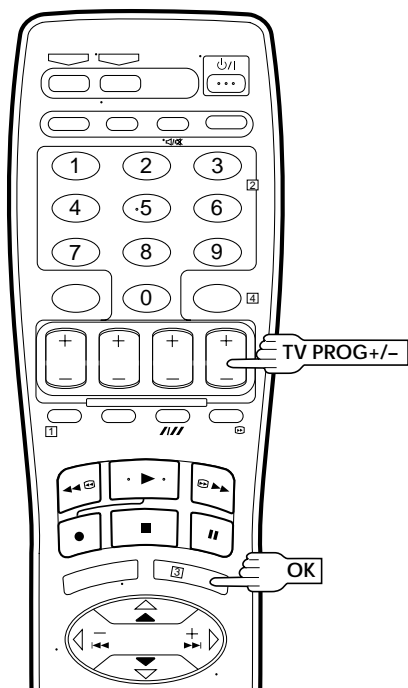
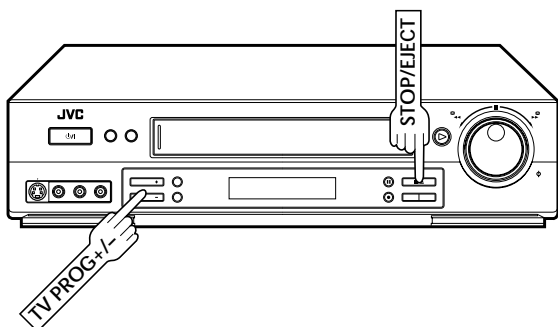

TEST SIGNAL

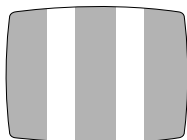

The channel on which the screen to the left appear clearly in step 3 is your Video Channel.

To view picture signals from the video recorder, set your TV to the Video Channel.

If you have connected the video recorder to your TV via the provided RF cable only (RF connection) – Go to "With RF Connection" below.

If you have connected the video recorder to your TV via both the provided RF cable and an AV cable (AV connection), or via the provided RF cable, the provided S-Video cable and an audio cable (S-VIDEO connection) – Go to "With AV Connection or S-VIDEO Connection" on next page.

With RF Connection

IMPORTANT:

Before performing the following steps, make sure the recorder's power is off and there is no cassette inserted in the recorder.

ACCESS VIDEO CHANNEL SET MODE

1

Hold down **STOP/EJECT** on the recorder until the display panel shows the following.

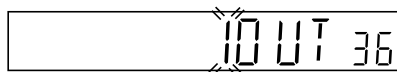

SELECT TV SYSTEM

2

Press **TV PROG +** or **-** to set appropriate TV system that matches the system of TV being used (refer to the table below).

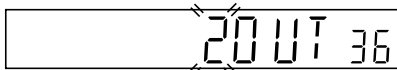

1 : B/G 2 : D/K 3 : I 4 : H 5 : M

Major Countries	TV System
New Zealand, Kuwait, U.A.E., Indonesia, Singapore, Thailand, Malaysia, Iran, Saudi Arabia, Egypt, Morocco, Lebanon, Iraq	B/G
China, Mongolia, Russia	D/K
Hong Kong	I
Australia	H
U.S.A., Japan, S.Korea, Taiwan	M

SET VIDEO CHANNEL

3

Set your TV to UHF channel 36.

- If the two vertical white bars appear clearly on the screen as shown in the illustration (➡ "TEST SIGNAL" on page 6), press **OK** and then go to step 4.
- If the two vertical white bars do not appear clearly, press **OK** and then **TV PROG +** or **-** to set the video recorder to a vacant channel between 28 and 60 which is not occupied by any local station in your area.

(Ex.) If channel 50 is available in your area

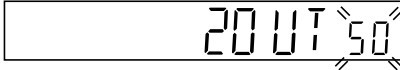

Then set your TV to UHF channel 50 and check if the two vertical white bars appear clearly on the screen; if so, go to step 4. If not, re-set the video recorder to another vacant channel and try again.

NOTES:

- If you set the video recorder to a channel which is occupied by a local station or has neighbouring channels that are occupied by local stations, the picture reception quality will be affected and some interference noise will appear on the TV screen. Be sure to select a vacant channel which has no broadcast on neighbouring channels.
- If you cannot obtain the two vertical white bars clearly with any channel between 28 and 60, consult your JVC dealer.

FINISH VIDEO CHANNEL SET

4

Press **OK**.

- If Auto Set Up (➡ pg. 8) or Tuner Set (➡ pg. 42) has not previously been performed, the Language Select screen appears and Auto Set Up function takes place automatically.

With AV Connection or S-VIDEO Connection

IMPORTANT:

Before performing the following steps, make sure the recorder's power is off and there is no cassette inserted in the recorder.

ACCESS VIDEO CHANNEL SET MODE

1

Hold down **STOP/EJECT** on the recorder until the display panel shows the following.



SET VIDEO CHANNEL

2

Press **OK**, then press **TV PROG -** until the display panel shows the following.

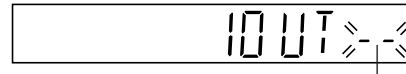

Now the video channel is set to off (- -).

FINISH VIDEO CHANNEL SET

3

Press **OK**.

- If Auto Set Up (➡ pg. 8) or Tuner Set (➡ pg. 42) has not previously been performed, the Language Select screen appears and Auto Set Up function takes place automatically.

To view picture signals from the video recorder, set your TV to its AV mode.

Be sure to connect the power plug to an AC outlet first before installing the lithium battery; otherwise, the battery's service life will be drastically shortened.

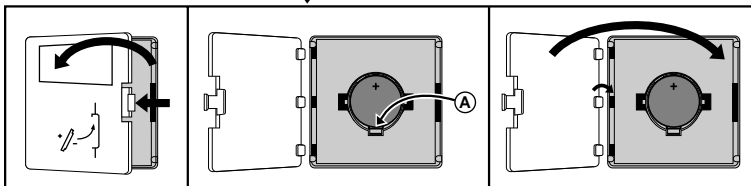
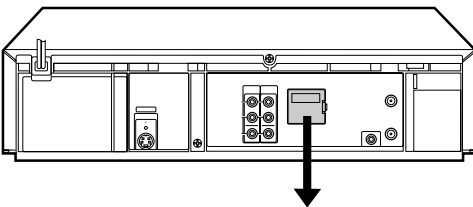

Installing/Removing the lithium battery

- 1 Make sure that the power plug is connected to an AC outlet and turn off the recorder power.
- 2 Open the battery cover while pressing the release tab as illustrated.
- 3 Insert a lithium battery with the plus (+) side up and push it in.
 - To remove the lithium battery, press the latch (A) downward using a pointed non-metallic object, then pull out the lithium battery.
- 4 Close the battery cover until it clicks in place.

Auto Set Up

IMPORTANT

- Don't press any buttons on the recorder or remote that are not directly related to the step you are performing while Auto Set Up is in progress.
- If you perform Auto Set Up successfully during installation, there's no need to separately perform the Language Select, Clock Set or Channel Set procedures, but if adjustments become necessary they can be performed as follows:
 - To change the selected language [pg. 11](#)
 - To reset or adjust the time [pg. 12](#)
 - To add/delete channels manually [pg. 43](#)
 - To reset the tuner after moving to a different location [pg. 42](#)

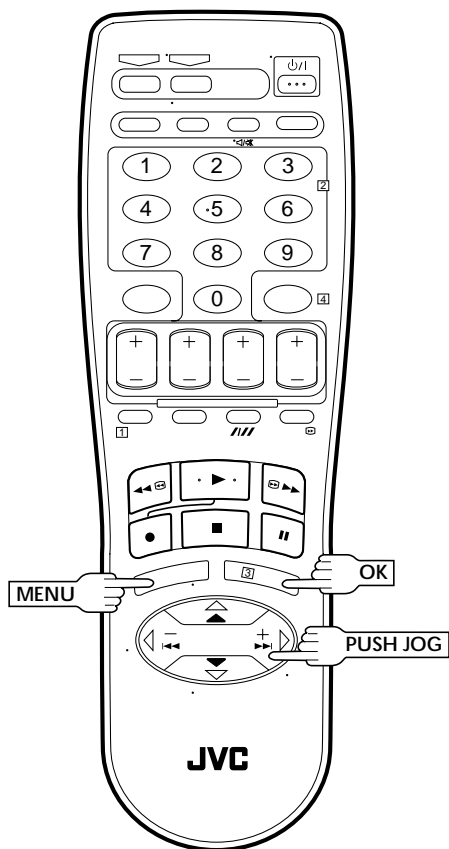

The Auto Set Up function simplifies installation by guiding you through the procedures of setting the language, clock and tuner channels — simply follow the on-screen menus that appear.

Before starting, make sure of the following:

- The TV aerial cable should be connected to the recorder.
- The recorder's mains power cord should be connected to a mains outlet. [pg. 4, 5](#)
- The "Video Channel Set" procedure should be done first and the TV should be set to its AV mode (with AV or S-VIDEO connection [pg. 7](#)) or video channel (with RF connection [pg. 6](#)).

1

SELECT LANGUAGE

Press **PUSH JOG** $\Delta\nabla$ to place the pointer next to your desired language (English or Chinese), then press **OK** or **PUSH JOG** \triangleright .

- The Clock Set screen appears.

2

SET TIME

Press **PUSH JOG** $\Delta\nabla$ to set the time, then press **OK** or **PUSH JOG** \triangleright .

- Press and hold either button to delay or advance the time by 30 minutes.

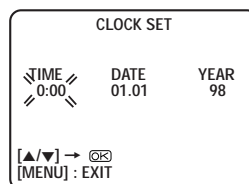

3

SET DATE

Press **PUSH JOG** $\Delta\nabla$ to set the date, then press **OK** or **PUSH JOG** \triangleright .

- Press and hold either button to change the date by 15 days.

4

SET YEAR

Press **PUSH JOG** $\Delta\nabla$ to set the year, then press **MENU**.

Major Countries	TV System
Australia, New Zealand, Kuwait, U.A.E., Indonesia, Singapore, Thailand, Malaysia, Iran, Saudi Arabia, Egypt, Morocco, Lebanon, Iraq	B/G
China, Mongolia, Russia	D/K
Hong Kong	I
U.S.A., Japan, S.Korea, Taiwan	M

5 SELECT TV SYSTEM

Press **PUSH JOG** $\Delta \nabla$ to place the pointer next to the appropriate TV system (refer to the table on the left).

6 START AUTO CHANNEL SET

Press **OK** or **PUSH JOG** \triangleright .

- The Auto Set Up function scans all the channels that are receivable by your recorder. It then automatically assigns each receivable channels to the **TV PROG** buttons. It skips non-receivable channels.
- As Auto Set Up progresses, the "■" mark on the screen moves from left to right. (See below.)

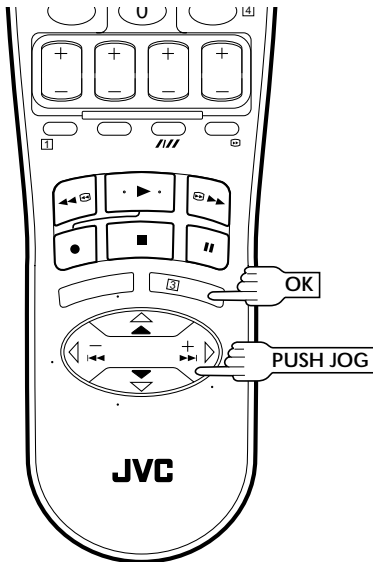

DO NOT press any button on the recorder or remote control while Auto Set Up is in progress.

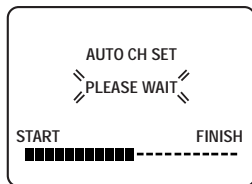

During Auto Set Up
"PLEASE WAIT" blinks on the screen and "Auto" blinks on the front display panel.

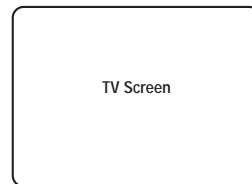

When Auto Set Up is completed, the lowest position number will appear on the front display panel.

NOTES:

- If you perform Auto Set Up when the aerial cable is not connected properly, "SCAN COMPLETED -NO SIGNAL-" appears on the screen. When this happens, make sure of the aerial connection and press **OK**; Auto Set Up will take place again.
- If there is a power cut, or if you press **⏻** or **MENU** while Auto Set Up is in progress, Auto Set Up will be interrupted; be sure to turn off the recorder power once and try again.
- If you want to set the tuner manually such as to add or skip channels, to swap channel positions, or to fine-tune channels, \rightarrow pg. 43 - 45.
- If no sound accompanies the picture or the audio sounds unnatural on some channels that have been stored by Auto Set Up, the TV system setting for those channels may be incorrect. Select the appropriate TV system for those channels. \rightarrow "TV System Selection - When you see the picture but the audio can't be heard or sounds unnatural" on page 45.

On-Screen Displays

Turn on the TV and select the VIDEO channel (or AV mode).

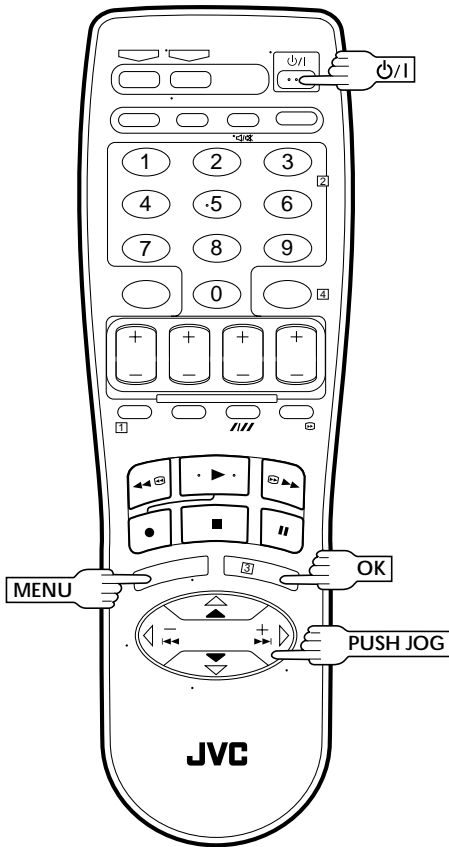

You can choose whether or not to have various operational indicators appear on screen, by setting this function ON or OFF.

1 TURN ON THE RECORDER

Press **⏻/I**.

2 ACCESS MAIN MENU SCREEN

Press **MENU**.

3 ACCESS FUNCTION SET SCREEN

Place the pointer next to "FUNCTION SET" by pressing **PUSH JOG** Δ/∇ , then press **OK** or **PUSH JOG** \triangleright .

4 ENABLE/DISABLE ON-SCREEN DISPLAY

The default setting is "ON", so if you want on-screen displays, leave the setting as it is and go to step 5. If you don't want the displays to appear, press **PUSH JOG** Δ/∇ to place the pointer next to "O.S.D." and press **OK** or **PUSH JOG** \triangleright to set to "OFF".

FUNCTION SET		
AUTO TIMER		OFF
O.S.D.	O.S.D.	ON
B. E. S. T.		ON
AUTO SP \rightarrow LP TIMER		OFF
S-VHS		ON
EDIT		OFF
O.S.D.	O.S.D.	ON
[Δ/∇] \rightarrow [OK]		
[MENU] : EXIT		

5 RETURN TO NORMAL SCREEN

Press **MENU**.

NOTES:

- When you use this recorder as the player for editing, be sure to set "O.S.D." to "OFF" before starting.
- During playback, the operation mode indicators may be disturbed depending on the type of tape being used.

The superimposed indication on the TV screen tells you what the recorder is doing.

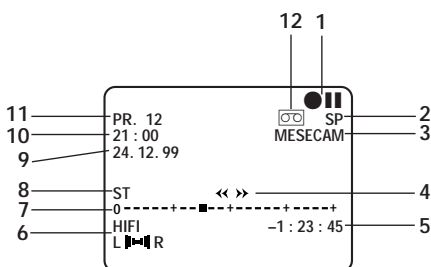

- 1- Operation mode indicators
- 2- Tape speed SP/LP/EP
- 3- Colour system indicator (pg. 40)
- 4- Tape direction
- 5- Counter display
- 6- Audio mode display (pg. 16)
- 7- Tape position indicator (pg. 16)
- 8- Type of Broadcast (pg. 19)
- 9- Current day/month/year
- 10- Clock display
- 11- Channel position number/Aux. indicator (L-1, F-1 or S-1)
- 12- Cassette loaded mark

Select Language

Turn on the TV and select the VIDEO channel (or AV mode).

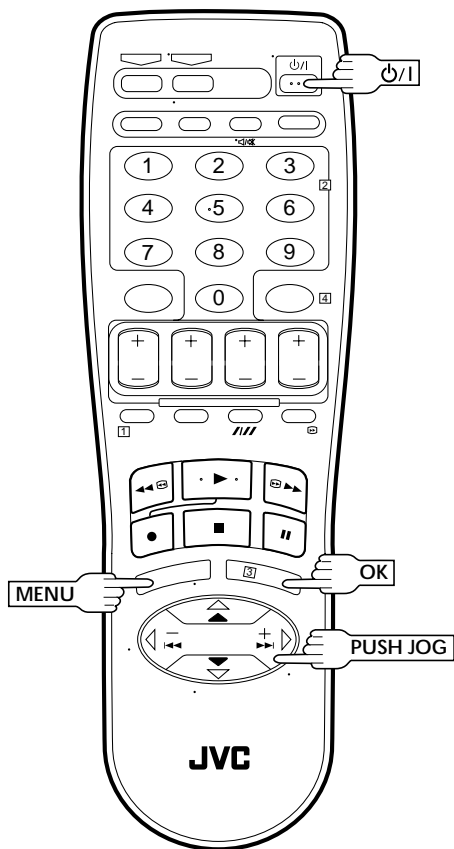

1 TURN ON THE RECORDER

Press **⏻/I**.

2 ACCESS MAIN MENU SCREEN

Press **MENU**.

3 ACCESS INITIAL SET SCREEN

Press **PUSH JOG** $\Delta \nabla$ to place the pointer next to "INITIAL SET", then press **OK** or **PUSH JOG** \triangleright .

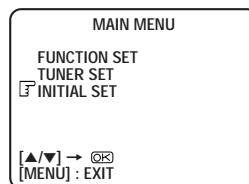

4 ACCESS LANGUAGE SELECT SCREEN

Press **PUSH JOG** $\Delta \nabla$ to place the pointer next to "LANGUAGE", then press **OK** or **PUSH JOG** \triangleright .

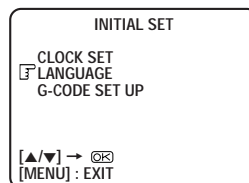

5 SELECT LANGUAGE

Place the pointer next to the language of your choice (English or Chinese) by pressing **PUSH JOG** $\Delta \nabla$, then press **OK** or **PUSH JOG** \triangleright .

6 RETURN TO NORMAL SCREEN

Press **MENU**.

Clock Set

Turn on the TV and select the VIDEO channel (or AV mode).

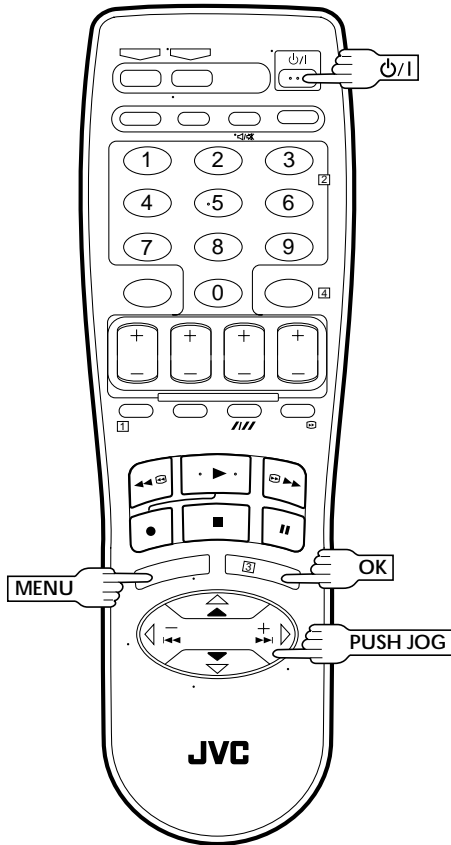

NOTE:

If the year digits are automatically cleared, it is possible that you have input February 29th in a non-leap year. Input the correct data.

1 TURN ON THE RECORDER

Press P/I .

2 ACCESS MAIN MENU SCREEN

Press **MENU**.

3 ACCESS INITIAL SET SCREEN

Press **PUSH JOG** Δ/∇ to place the pointer next to "INITIAL SET", then press **OK** or **PUSH JOG** \triangleright .

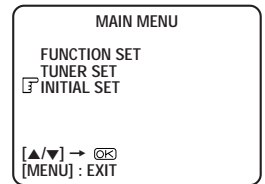

4 ACCESS CLOCK SET SCREEN

Press **PUSH JOG** Δ/∇ to place the pointer next to "CLOCK SET", then press **OK** or **PUSH JOG** \triangleright . The Clock Set screen appears.



5 SET TIME

Press **PUSH JOG** Δ/∇ to set the time, then press **OK** or **PUSH JOG** \triangleright .

- Press and hold either button to delay or advance the time by 30 minutes.

6 SET DATE

Press **PUSH JOG** Δ/∇ to set the date, then press **OK** or **PUSH JOG** \triangleright .

- Press and hold either button to change the date by 15 days.

7 SET YEAR

Press **PUSH JOG** Δ/∇ to set the year.

8 START CLOCK OPERATION

Press **MENU**.

Basic Playback

Turn on the TV and select the VIDEO channel (or AV mode).

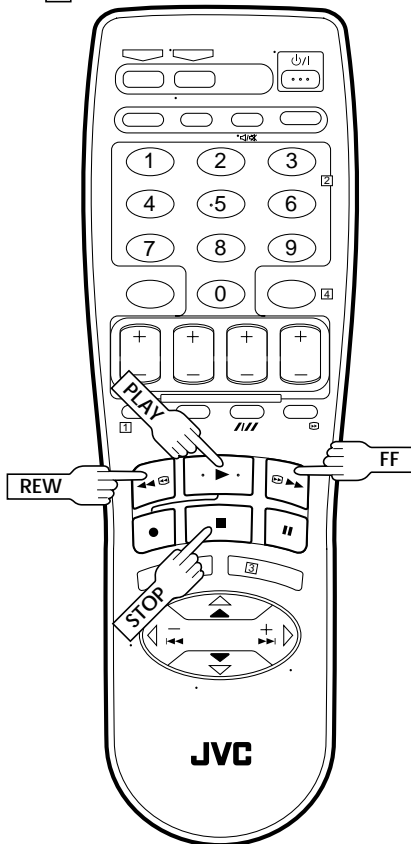
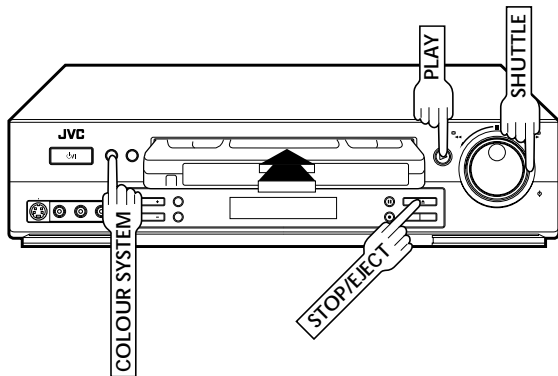

The easiest, most basic operation possible with your video recorder is tape playback. Already-recorded signals on a video tape are read by your video recorder and displayed on your TV just like a TV programme.

S-VHS playback is possible only with S-VHS PAL tapes recorded in SP or LP, or S-VHS NTSC tapes recorded in the SP or EP mode.

1

LOAD A CASSETTE

Make sure the window side is up, the rear label side is facing you and the arrow on the front of the cassette is point toward the recorder. Don't apply too much pressure when inserting.

- The recorder power comes on automatically and the counter is reset to 0:00:00.
- Select the appropriate colour system by pressing the **COLOUR SYSTEM** button (see pg. 40).
- If the record safety tab has been removed, playback begins automatically (see pg. 17).

2

FIND PROGRAMME START POINT

If the tape is advanced past the start point, press **REW** or turn the **SHUTTLE** ring to the left. To go forward, press **FF** or turn the **SHUTTLE** ring to the right.

3

START PLAYBACK

Press **PLAY**. "BEST" appears blinking in the recorder's display panel during automatic tracking (see pg. 22).

4

STOP PLAYBACK

Press **STOP** on the remote or **STOP/EJECT** on the recorder's front panel. Then press **STOP/EJECT** to remove the cassette.

Usable cassettes

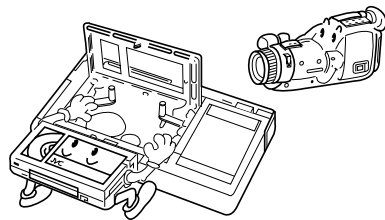

- Compact VHS camcorder recordings can be played on this video recorder. Simply place the recorded cassette into a VHS Cassette Adapter and it can be used just like any full-sized VHS cassette.
- This video recorder can record on regular VHS and Super VHS cassettes. While only VHS signals can be recorded on regular VHS cassettes, both VHS and Super VHS signals can be recorded and played back using Super VHS cassettes.

* By using S-VHS ET it is possible to record and play back with S-VHS picture quality on VHS cassettes with this recorder (see pg. 21).

Playback Features

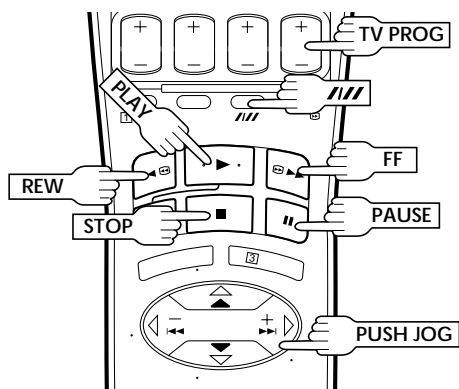
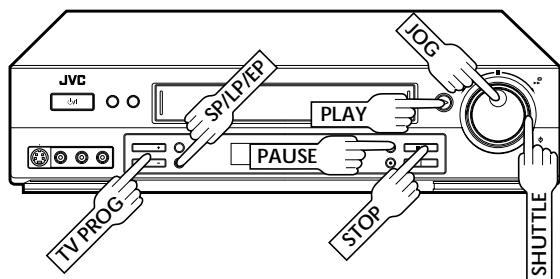

NOTE:

Refer to the **SHUTTLE** ring illustration to the right as you read the following procedures.

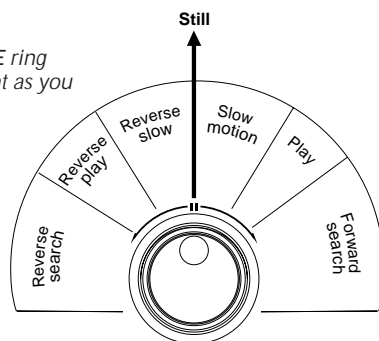

Still Picture/Frame-By-Frame Playback

1 PAUSE DURING PLAYBACK

Press **PAUSE**. If there is vertical jitter, use the **TV PROG** buttons to correct the picture.

2 ACTIVATE FRAME-BY-FRAME PLAYBACK

Turn the **JOG** dial to the right for forward frame-by-frame playback, or to the left for reverse frame-by-frame playback.

OR

Press **PAUSE**.

OR

Press **PUSH JOG** ◀ or ▶.

To resume normal playback, press **PLAY**.

High-Speed Search

1 ACTIVATE HIGH-SPEED SEARCH

During playback or still, turn the **SHUTTLE** ring all the way to the right for forward high-speed search, or to the left for reverse high-speed search.

- For forward search with a visible picture, turn the **SHUTTLE** ring all the way to the right and release it within 1 second.
- For reverse search with a visible picture, turn the **SHUTTLE** ring all the way to the left and release it within 1 second.

OR

During playback or still, press **FF** for forward high-speed search, or **REW** for reverse high-speed search.

To resume normal playback, press **PLAY**.

NOTE:

For short searches, press and hold **FF** or **REW** during playback or still picture. When released, normal playback resumes.

Slow Motion

1 ACTIVATE SLOW-MOTION PLAYBACK

During playback or still, turn the **SHUTTLE** ring to the right for forward slow motion, or to the left for reverse slow motion (refer to the above illustration).

OR

During still picture, press and hold **PAUSE** for 2 seconds, then release. Press and release again to return to still picture.

OR

During still picture, press and hold **PUSH JOG** ◀ or ▶. Release to return to still picture.

To resume normal playback, press **PLAY**.

ATTENTION

In the search, still, slow-motion or frame-by-frame playback mode,

- the picture will be distorted.
- the noise bars will appear.
- there may be a loss of colour.

Variable-Speed Search

1

ACTIVATE VARIABLE-SPEED SEARCH

During playback or still, turn the **SHUTTLE** ring to the right for forward variable-speed search, or to the left for reverse variable-speed search (refer to the illustration on page 14).

OR

During playback, press **PUSH JOG** ◀ or ▶.

- The more times you press, the faster the playback picture moves.
- To decrease speed, press the button for the opposite direction.

To resume normal playback, press **PLAY**.

Index Search

Your recorder automatically marks index codes at the beginning of each recording. This function gives you quick access to any one of 9 index codes in either direction.



NOTE:

Before starting, make sure the recorder is in the Stop mode.

1

ACTIVATE INDEX SEARCH

Press **PUSH JOG** ◀ or ▶ (◀◀◀ or ▶▶▶) on the remote control. "◀◀◀ 1" or "▶▶▶ 1" is displayed on screen and search begins in the corresponding direction.

- To access index codes 2 through 9, press **PUSH JOG** ◀ or ▶ repeatedly until the correct index number is displayed.

Ex.: To locate the beginning of B from the current position, press **PUSH JOG** ◀ twice.
To locate the beginning of D from the current position, press **PUSH JOG** ▶ once.

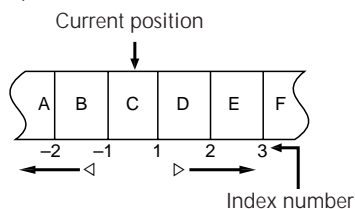

- When the specified index code is located, playback begins automatically.

Manual Tracking

Your video recorder is equipped with automatic tracking control. During playback, you can override this and adjust the tracking manually by pressing the **TV PROG** buttons.

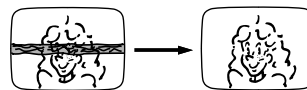

1

OVERRIDE AUTOMATIC TRACKING

Press **///** (SP/LP/EP) on the remote to engage manual tracking.

2

ADJUST TRACKING MANUALLY

Press **TV PROG** + or - to adjust tracking.

3

RETURN TO AUTOMATIC TRACKING

Press **///** (SP/LP/EP) on the remote to re-engage automatic tracking.

NOTE:

When a new tape is inserted, the recorder enters the automatic tracking mode automatically.

Repeat Playback

Your video recorder can automatically play back the whole tape 50 times repeatedly.

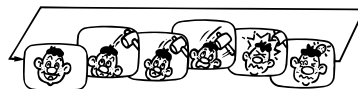

1

START PLAYBACK

Press **PLAY**.

2

ACTIVATE REPEAT PLAYBACK

Press **PLAY** and hold for over 5 seconds, then release.

- The Play indicator (▶) on the display panel blinks slowly.
- The tape plays 50 times automatically, and then stops.

3

STOP PLAYBACK

Press **STOP** at any time to stop playback.

NOTE:

Pressing **PLAY**, **REW**, **FF** or **PAUSE** also stops Repeat Playback.

Next Function Memory

You can set your recorder's power to go off automatically after the tape is fully rewound. Before starting, make sure the recorder is in the Stop mode.
For Automatic Power Off After Tape Rewind . . .
. . . press **REW**, then press **⏻** within 2 seconds.

Tape Position Indicator

The tape position indicator appears on screen when, from the Stop mode, you press **FF**, **REW** or perform an Index Search. The position of "■" in relation to "0" (beginning) or "+" (end) shows you where you are on the tape.
"O.S.D." (ⓘ pg. 10) must be set to "ON", or the indicator will not appear.

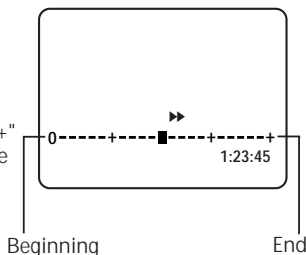

NOTE:

Depending on the type of tape used, there may be times when the indication is not correct.

Skip Search

1 SKIP OVER UNWANTED SECTIONS

Press **30 SEC 1** to 4 times during playback. Each press initiates a 30-second period of fast-motion playback. Normal playback resumes automatically.

NOTE:

To return to normal playback during a Skip Search, press **PLAY**.

Instant ReView

Simply by pressing a single button, the recorder power comes on, rewinds, and begins playback of the last timer-recorded programme. If you have several programmes recorded, you can easily access any of them.

NOTE:

Before starting, make sure that the recorder is off and that the Timer mode is disengaged.

1 ACTIVATE INSTANT REVIEW

Press **REVIEW**. The recorder power comes on and the recorder searches for the index code indicating the start of the last timer-recorded programme. Once it's found, playback begins automatically.

- The front display panel tells you how many programmes have been recorded. If you have, for example, 3 programmes, "REVIEW" and "3" appear and blink. To watch the first of the 3 programmes, press **REVIEW** three times. The recorder searches and begins playback automatically. You can access a programme as far as 9 index codes away from the current tape position.

NOTE:

Instant ReView is not possible while the recorder is in the Timer mode.

Soundtrack Selection

Your video recorder is capable of recording three soundtracks (HI-FI L, HI-FI R and NORM) and will play back the one you select.

During Playback

Pressing **AUDIO** on the remote control changes the soundtrack being played back as follows:

TRACK		USE
Recorder's Front Panel	On-Screen Display	
▶ ◀	HI FI L ■■■ R	For Hi-Fi stereo tapes
▶	HI FI L ■■	For main audio of Bilingual tapes
◀	HI FI ■■■ R	For sub audio of Bilingual tapes
NORM	NORM	For audio-dubbed tapes
▶ NORM ◀	HI FI NORM	For audio-dubbed tapes

NOTES:

- "▶ ◀" should normally be selected. In this mode, Hi-Fi stereo tapes are played back in stereo, and the NORM track is played back automatically for tapes with only normal audio.
- For instructions on recording stereo and bilingual programmes, refer to page 19.
- "O.S.D." must be set to "ON" or the on-screen displays will not appear (ⓘ pg. 10).

Basic Recording

Turn on the TV and select the VIDEO channel (or AV mode).

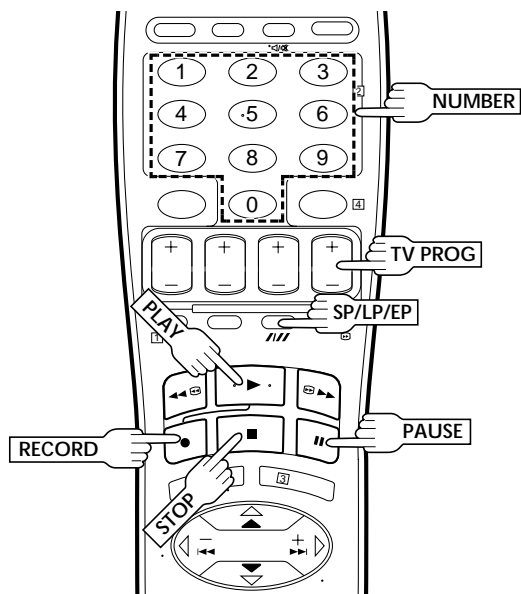
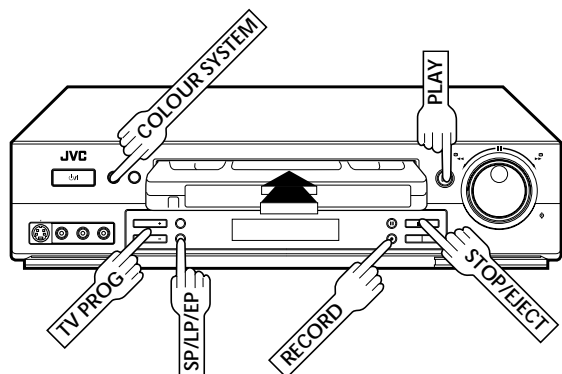

TV signals being received by the recorder's built-in tuner can be recorded onto a video tape. You can "capture" a TV programme using your video recorder.

S-VHS recording is possible only for PAL recordings made in the SP or LP mode, or NTSC recordings made in the SP mode.

S-VHS ET recording is possible only for PAL recordings made in the SP mode, or NTSC recordings made in the SP mode.

LOAD A CASSETTE

1

Insert a cassette with the record safety tab intact.

- The counter is reset to 0:00:00 and the recorder power comes on automatically.
- Select the appropriate colour system by pressing the **COLOUR SYSTEM** button (see pg. 40).

CHOOSE A PROGRAMME

2

Press **TV PROG +/-** or the **NUMBER** keys to select the channel you wish to record.

SET TAPE SPEED

3

Press **SP/LP/EP (||||)**. Check the SP/LP/EP indicator on the recorder display panel to confirm the selected tape speed.

START RECORDING

4

Press and hold **RECORD** and **PLAY** on the remote control, or press **RECORD** on the recorder.

B.E.S.T. takes place at the beginning of each first SP and first LP (or EP) recording after inserting the cassette (see pg. 22).

PAUSE/RESUME RECORDING

5

Press **PAUSE**. Press **PLAY** to resume recording.

STOP RECORDING

6

Press **STOP** on the remote control or **STOP/EJECT** on the recorder. Then press **STOP/EJECT** to remove the cassette.

NOTE:

When recording in NTSC, if EP is selected, recording will always be done in the VHS mode even if an S-VHS cassette is used.

Accidental erasure prevention

- To prevent accidental recording on a recorded cassette, remove its safety tab. To record on it later, cover the hole with adhesive tape.

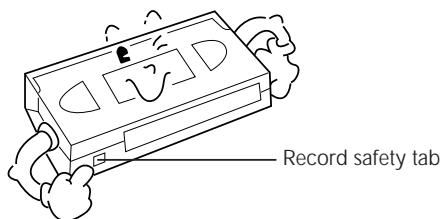

Recording Resume Function

If there is a power outage during recording (or Instant Timer Recording or timer recording), the recording will resume automatically when power is restored to the recorder unless the recorder's memory backup has expired.

Recording Features

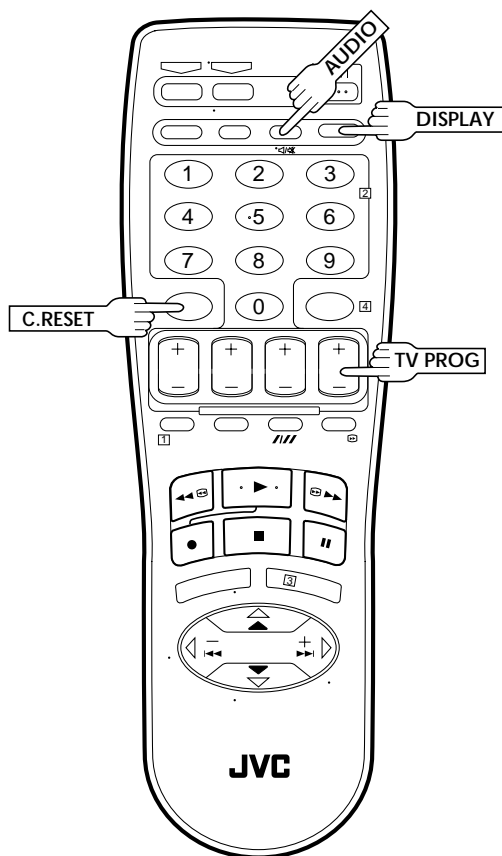
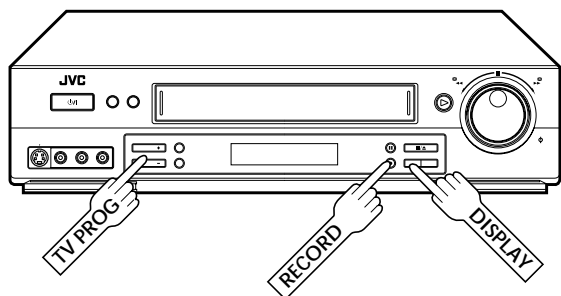

Record One Programme While Watching Another

1 SELECT CHANNEL TO WATCH

Once recording is in progress, all you need to do is to set the channel controls on the TV for the station you wish to view.

- The programme selected with the TV's channel controls appears on the TV screen while the one selected with the **TV PROG** buttons is recorded on the tape.

Elapsed Recording Time Indication

You can check the exact time of a recording.

1 SET COUNTER DISPLAY

Press **DISPLAY** until a counter reading appears on the display panel.

- By pressing the **DISPLAY** button, you can change the display to show the counter reading, channel position*, clock time.
*Channel position is not displayed during playback.

2 RESET COUNTER

Press **C. RESET** before starting recording or playback.

- The counter is reset to "0:00:00" and shows the exact elapsed time as the tape runs.

Instant Timer Recording (ITR)

This easy method lets you record for from 30 minutes to 6 hours (selectable in 30-min. increments), and shuts the recorder off after recording is finished.

- 1** **START RECORDING**
Press **RECORD** on the recorder.
- 2** **ENGAGE ITR MODE**
Press **RECORD** again. "○" blinks and 0:30 appears on the front display panel.
- 3** **SET RECORDING DURATION**
If you want to record for more than 30 minutes, press **RECORD** to extend the time. Each press extends recording time by 30 minutes.

NOTE:

You can only perform ITR using the **RECORD** button on the recorder's front panel.

Receiving Stereo And Bilingual Programmes

Your recorder is equipped with a Sound-Multiplex decoder (A2) and a Digital stereo sound decoder (NICAM) as well, making reception of stereo and bilingual broadcasts possible.

When the channel is changed, the type of broadcast being received will be displayed on the TV screen for a few seconds.

Type of Broadcast Being Received	On-screen Display
A2 Stereo	ST
A2 Bilingual	BIL
Regular Monaural	(none)
NICAM Stereo	ST NICAM
NICAM Bilingual	BIL NICAM
NICAM Monaural	NICAM

- To listen to a stereo programme, press **AUDIO** until "◻" and "◻" appear on the front display panel or "HIFI L ◻ R" appears on the screen.
- To listen to a bilingual programme, press **AUDIO** until "◻" or "◻" appears on the front display panel, or "HIFI L ◻ R" or "HIFI ◻ R" appears on the screen (as required).
- To listen to the Standard (regular monaural) audio while receiving a NICAM broadcast, press **AUDIO** until "NORM" appears on the front display panel or on the screen.

NOTE:

"O.S.D." must be set to "ON" or the on-screen displays will not appear (☞ pg. 10).

To Record Stereo And Bilingual Programmes (A2)

- Stereo programmes are automatically recorded in stereo on the Hi-Fi audio track (with the normal audio track recording mixed L and R channel sound).
- Bilingual programmes are automatically recorded in bilingual on the Hi-Fi audio track. The main soundtrack will be recorded on the normal audio track.

To Record NICAM Stereo And Bilingual Programmes

The NICAM audio programme will be recorded on the Hi-Fi audio track, and the Standard audio programme on the normal audio track.

NOTES:

- If the quality of stereo sound being received is poor, the broadcast will be received in monaural with better quality.
- Before playing back a programme recorded in stereo, or a bilingual programme, refer to "Soundtrack Selection" (☞ pg. 16).

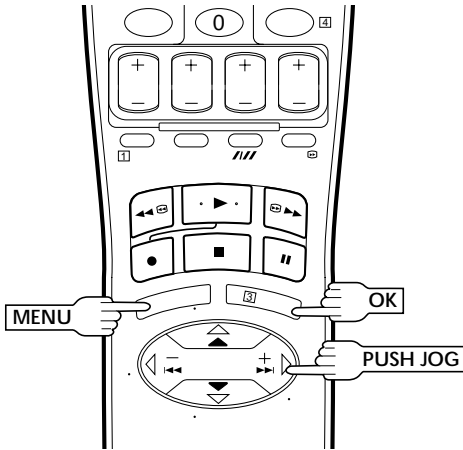
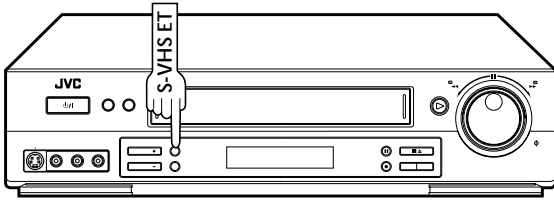

S-VHS (Super VHS), S-VHS ET and VHS

Your recorder can record in S-VHS, S-VHS ET or VHS.

S-VHS allows you to make high quality video recordings with a horizontal resolution of 400 lines. This compares with the 240 lines of resolution of normal VHS recordings. To achieve the highest quality picture we recommend that you record in S-VHS mode.

By using S-VHS ET it is possible to record and play back with S-VHS picture quality on VHS cassettes with this recorder. For details, refer to page 21.

To record in S-VHS;

- perform the steps 1 – 4 below to set the "S-VHS" to "ON".
- then, insert a cassette marked "S-VHS", the S-VHS indicator will light on the display panel.

The S-VHS recording mode will be automatically selected.

To record in S-VHS ET on a VHS high grade cassette;

- press **S-VHS ET** and set to "ON".

☞ "Super VHS ET" on page 21.

To record in VHS;

- insert a cassette marked "VHS".
- press **S-VHS ET** and set to "OFF".

The VHS recording mode will be automatically selected regardless of the S-VHS mode setting.

To record in VHS on an S-VHS cassette;

- insert the cassette marked "S-VHS", the S-VHS indicator will light on the display panel.

- then, perform the steps 1 – 4 below to set the "S-VHS" to "OFF"; the S-VHS indicator will go out.

The VHS recording mode will be selected.

ATTENTION

- S-VHS recording is possible only for PAL recordings made in the SP or LP mode, or NTSC recordings made in the SP mode.
- S-VHS ET recording is possible only for PAL recordings made in the SP mode, or NTSC recordings made in the SP mode.
- When recording NTSC signals in S-VHS or S-VHS ET, be sure to select "AUTO" or "NTSC3.58" by pressing the **COLOUR SYSTEM** button (☞ pg. 40).

NOTES:

- When playing back a tape that has been recorded in S-VHS or S-VHS ET, the S-VHS indicator lights on the display panel regardless of the "S-VHS" mode setting.
- Tapes recorded in S-VHS or S-VHS ET mode can not be played back successfully on normal VHS recorders.

1 ACCESS MAIN MENU SCREEN

Press **MENU**.

2 ACCESS FUNCTION SET SCREEN

Press **PUSH JOG** $\Delta \nabla$ to place the pointer next to "FUNCTION SET", then press **OK** or **PUSH JOG** \triangleright .

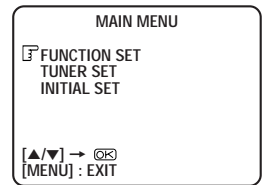

3 SELECT S-VHS MODE

Press **PUSH JOG** $\Delta \nabla$ to place the pointer next to "S-VHS", then press **OK** or **PUSH JOG** \triangleright to select "ON" or "OFF".

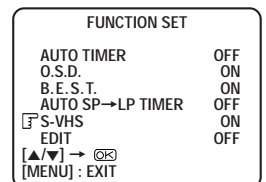

4 RETURN TO NORMAL SCREEN

Press **MENU**.

Super VHS ET

Your recorder is equipped with Super VHS ET that makes it possible to record with S-VHS picture quality on VHS cassettes.

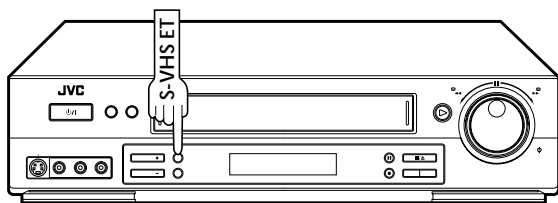

1 SELECT S-VHS ET SET MODE

Press **S-VHS ET**. The current setting appears on the screen for about 5 seconds.

S-VHS ET : OFF

2 ENGAGE S-VHS ET MODE

While the current setting is displayed on the screen, press **S-VHS ET** again to set to "ON".

- The "S-VHS" indicator lights on the front display panel.

NOTES:

- You cannot activate the S-VHS ET function...
 - ...while recording is in progress.
 - ...while timer-recording (incl. Instant Timer Recording pg. 19) is in progress.
 - ...while B.E.S.T. (pg. 22) is in progress.
 - ...when the recorder's power is off.
- S-VHS ET does not work with S-VHS tapes.

S-VHS ET

This facility allows recording with S-VHS picture quality on VHS cassettes. You can play back those cassettes recorded in S-VHS ET on a recorder equipped with S-VHS ET.

NOTES:

- To obtain the highest quality recording and playback pictures over a longer period on this model, S-VHS recording on S-VHS tape is recommended.
- You can play back S-VHS ET recordings not only on this recorder but also on another VHS recorder equipped with S-VHS ET.
 - * It is recommended to specifically label S-VHS ET recordings so you can easily distinguish them from regular VHS recordings.
- S-VHS ET recordings can also be played back on an S-VHS recorder or a VHS recorder equipped with SQPB (S-VHS QUASI PLAYBACK) function. However, there may be cases where S-VHS ET playback is not possible on a particular recorder.
- Frequent still, frame-by-frame and slow-motion playback may damage the tape and cause picture degradation.
- With some tapes, better picture quality may not be obtained even with S-VHS ET recording. It is recommended that you do test record beforehand to make sure whether better results can be obtained.
- High Grade tapes are recommended for superior results.
- Make sure that "B.E.S.T." is set to "ON" (pg. 22).
- During S-VHS ET playback, noise may appear depending on tape quality.
- Noise may appear during search, still, frame-by-frame and slow-motion playback.
- If the playback picture becomes blurred or interrupted, use a cleaning cassette.

B.E.S.T. Picture System

Turn on the TV and select the VIDEO channel (or AV mode).

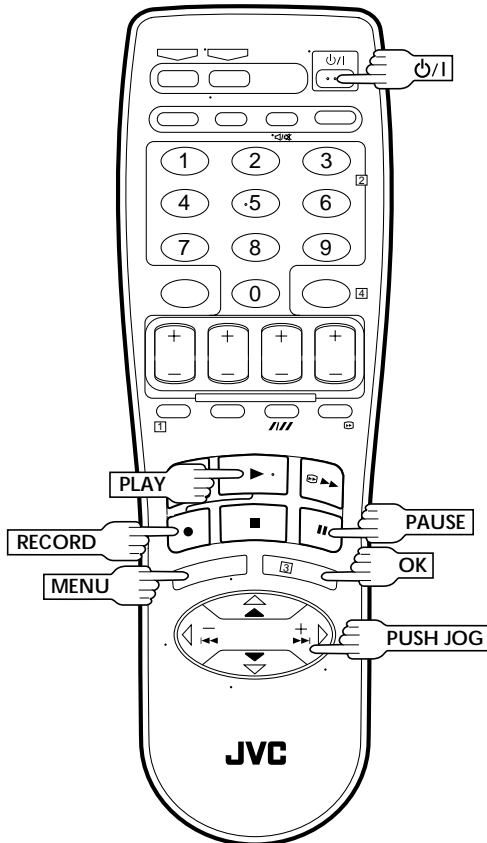
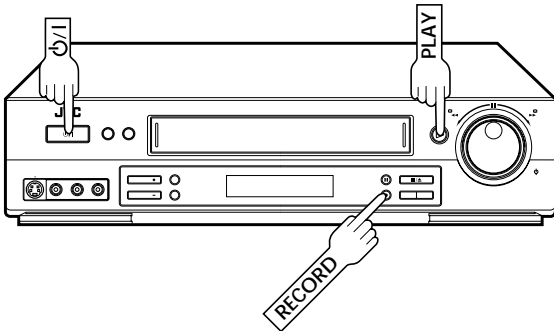

The B.E.S.T. (Biconditional Equalised Signal Tracking) system checks the condition of the tape in use during recording and playback, and compensates to provide the highest-possible recording and playback pictures. The default setting for both recording and playback is "ON".

Preparation

1 TURN ON THE RECORDER

Press P/I .

2 ACCESS MAIN MENU SCREEN

Press **MENU**.

3 ACCESS FUNCTION SET SCREEN

Place the pointer next to "FUNCTION SET" by pressing **PUSH JOG** $\Delta\nabla$, then press **OK** or **PUSH JOG** \triangleright .

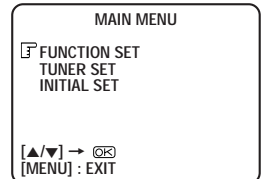

4 SELECT MODE

Place the pointer next to "B.E.S.T." by pressing **PUSH JOG** $\Delta\nabla$, then press **OK** or **PUSH JOG** \triangleright to set to "ON" or "OFF".

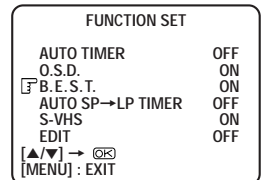

5 RETURN TO NORMAL SCREEN

Press **MENU**.

Recording

1

START RECORDING

Press and hold **RECORD** and press **PLAY** on the remote, or press **RECORD** on the recorder.

DURING B.E.S.T.

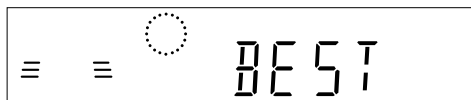

B.E.S.T. COMPLETE

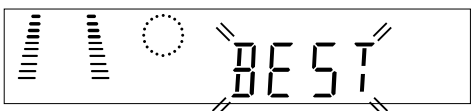

- The recorder spends approximately 7 seconds assessing the condition of the tape, then begins recording.

NOTES:

- The B.E.S.T. system works for both SP and LP (or EP) modes only after a tape has been inserted and the Record mode is first initiated. It does not work during recording.
- In the case of timer recording, the B.E.S.T. system works before recording is initiated.
- Once the cassette is ejected, the B.E.S.T. data is cancelled. The next time the cassette is used for recording, B.E.S.T. is re-performed.
- Pressing the recorder's **RECORD** button while "BEST" is displayed does not start Instant Timer Recording (▶ pg. 19).

ATTENTION

*Since the B.E.S.T. system works before recording actually starts, there is a delay of approximately 7 seconds after **RECORD** and **PLAY** on the remote are pressed, or **RECORD** on the recorder is pressed. To make sure you record the desired scene or programme in its entirety, first perform the following steps:*

- 1) Press and hold **PAUSE** and press **RECORD** to engage the **RECORD PAUSE** mode.
 - The recorder then automatically checks the condition of the tape and, after approximately 7 seconds, re-enters **RECORD PAUSE**.
- 2) Press **PLAY** to start recording.
 - If you want to bypass the B.E.S.T. system and begin recording immediately, set "B.E.S.T." to "OFF" in step 4 on page 22.

Playback

The recorder assesses the quality of the tape once you initiate playback.

1

START PLAYBACK

Press **PLAY**.

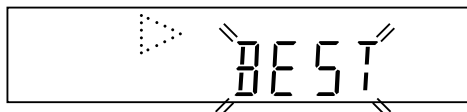

- The recorder adjusts the playback picture quality based on the quality of the tape in use.
- B.E.S.T. is active during Auto Tracking. "BEST" appears blinking on the recorder's display panel.

NOTES:

- When watching a tape recorded with "B.E.S.T." set to "ON", it is recommended that you leave B.E.S.T. on during playback as well.
- When watching a rental tape or one recorded on another video recorder, or when using this recorder as the player for editing, set B.E.S.T. to your preference by performing steps 1 through 5 on page 22.
- "BEST" only appears at the beginning of automatic tracking. Even though it doesn't appear after that, the B.E.S.T. function is operative.

G-CODE System Setup

Turn on the TV and select the VIDEO channel (or AV mode).

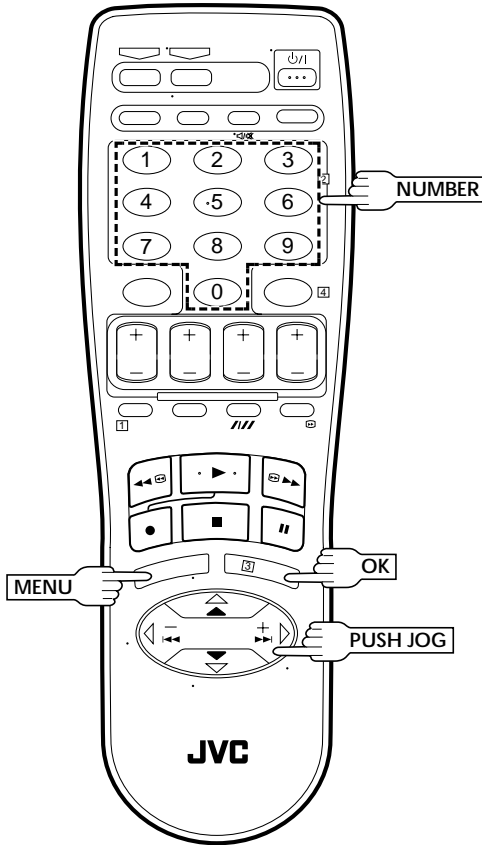

INFORMATION

G-CODE and SHOWVIEW are different trademarks used to represent the same easy recording feature, but only the term G-CODE system will be used in the instructions. If you use the SHOWVIEW system, follow the same instructions listed for the G-CODE system.

The G-CODE timer programming system eliminates the need to input channel, date, start and stop time data when setting the timer record function. Simply key in the G-CODE number for the TV programme you wish to record (found in most TV listings) and the recorder's timer is automatically programmed.

You have to set "GUIDE PROG" numbers, which are assigned to each station for purposes of G-CODE timer programming, for all the stations stored in your recorder's memory to get proper results.

Before G-CODE setup you must have performed the following procedures:

- Tuner setting (☞ pg. 8, 42)
- Clock setting (☞ pg. 12)

IMPORTANT

Perform the following procedure after Auto Set Up on page 8 and/or the channel setting steps on pages 42 - 45.

After setting the Guide Program Numbers, channel positions may be incorrect if you stored or skipped channels. In this case, re-perform Guide Program Number setting.

Guide Program Number Set

1 ACCESS MAIN MENU SCREEN

Press **MENU**.

2 ACCESS INITIAL SET SCREEN

Press **PUSH JOG** Δ / ∇ to place the pointer next to "INITIAL SET", then press **OK** or **PUSH JOG** \triangleright .

3 ACCESS G-CODE SET-UP

Press **PUSH JOG** Δ / ∇ to place the pointer next to "G-CODE SET-UP", then press **OK** or **PUSH JOG** \triangleright .

4 ENTER GUIDE PROG NUMBER

Press **PUSH JOG** Δ / ∇ or **NUMBER** keys to enter the Guide Program number for the desired station as shown in the TV listings. Then press **OK** or **PUSH JOG** \triangleright .

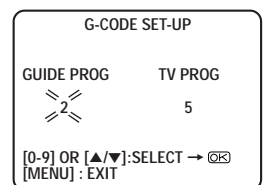

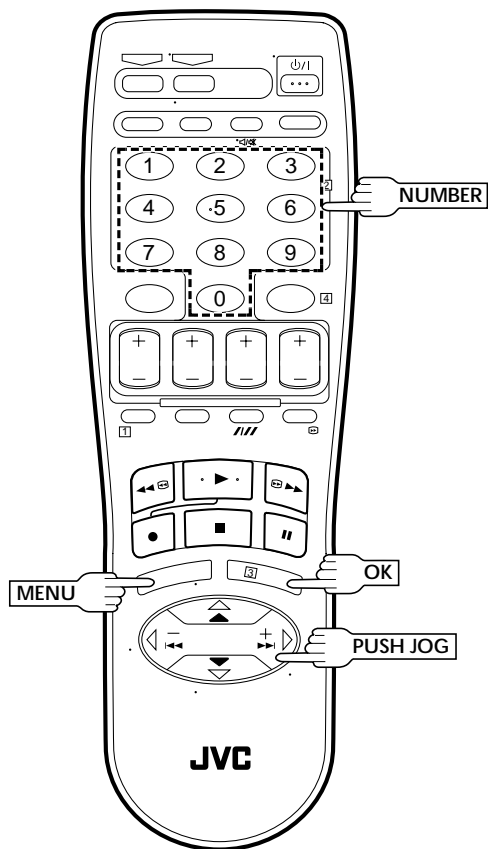

5 ENTER RECEIVING CHANNEL POSITION NUMBER

Press **PUSH JOG** $\Delta \nabla$ or **NUMBER** keys to input the number of the recorder's channel position on which the Guide Program number's broadcast is received. Then press **OK** or **PUSH JOG** \triangleright .

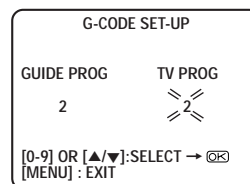

- If the satellite broadcast is received on your recorder's auxiliary channel "L-1", select "L-1" for the channel position.
- Repeat steps 4 and 5 as necessary.

6 RETURN TO NORMAL SCREEN

Press **MENU**.

Guide Program Number

"Guide Program (GUIDE PROG) number" refers to the assigned TV station numbers, according to broadcast area, for G-CODE timer recording. The Guide Program numbers can be found in most TV listings.

G-CODE Timer Programming

Before performing G-CODE Timer Programming:

- Be sure to read "G-CODE System Setup" (☞ pg. 24).
- Insert a cassette with the safety tab in place. The recorder will come on automatically.
- Turn on the TV and select the VIDEO channel (or AV mode).
- Select the appropriate colour system by pressing the COLOUR SYSTEM button (☞ pg. 40).

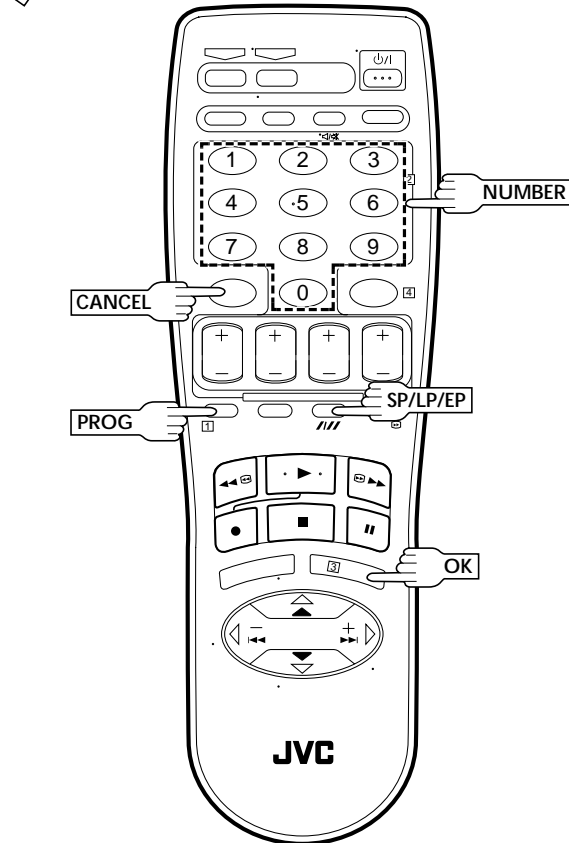
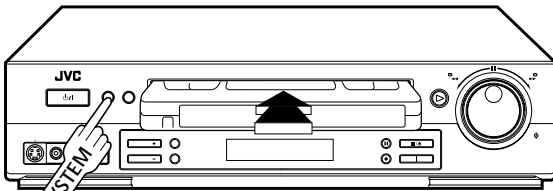

With the G-CODE system, timer programming is greatly simplified because each TV programme has a corresponding code number which your recorder is able to recognise.

1

ACCESS G-CODE SCREEN

Press **PROG.**

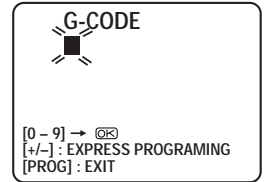

2

ENTER G-CODE NUMBER

Press the **NUMBER** keys to enter the G-CODE number of a programme you wish to record.

- If you make a mistake, press **CANCEL** and input the correct number.

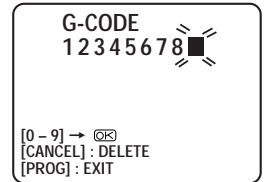

3

ACCESS G-CODE PROGRAMME SCREEN

Press **OK**, and the G-CODE Programme screen appears. (If you're just starting out, "P1" appears.)

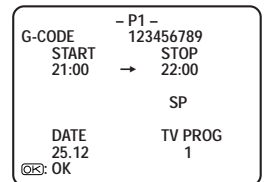

IMPORTANT

Make sure the channel position number you wish to record is displayed; if not, see "G-CODE System Setup" on page 24 and set the Guide Program number for that G-CODE number correctly.

- If the number you entered is invalid, "ERROR" appears on the screen. Press **CANCEL** and input a valid G-code number.
- If the "G-CODE SET-UP" screen appears, see "ATTENTION - Regarding Guide Program Number Set" on page 27.

4

SET TAPE SPEED

Press **SP/LP/EP (///)** to set the tape speed.

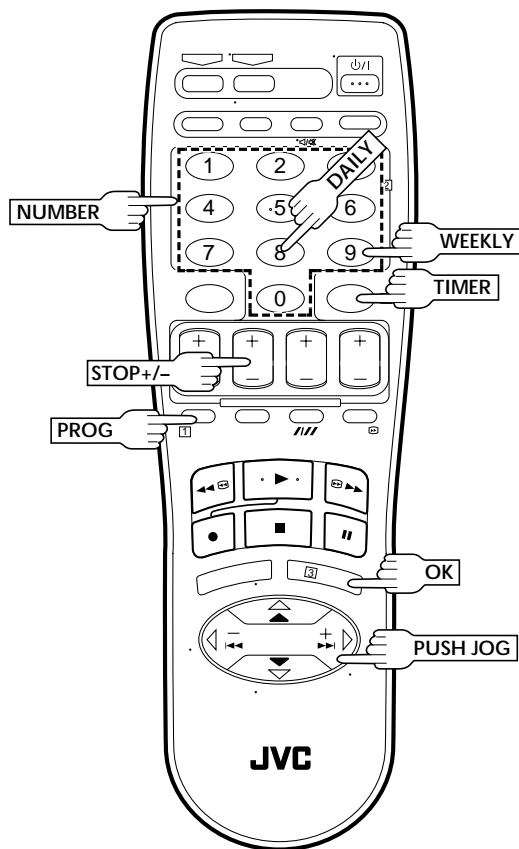

RETURN TO NORMAL SCREEN

5

Press **PROG** or **OK**. "PROGRAM COMPLETED" appears on the screen for about 5 seconds, then normal screen appears.

- Repeat steps 1 – 5 for each additional programme.

ENGAGE RECORDER'S TIMER MODE

6

Press **TIMER**. The recorder turns off automatically and "Ⓞ" appears on the display panel.

- To disengage the timer, press **TIMER** again.

NOTES:

- To Change The Stop Time . . .
 . . . press **STOP +/-** after pressing **OK** in step 3. You can compensate for anticipated programme schedule delays this way.
- To Timer-Record Weekly Or Daily Serials . . .
 . . . after pressing **OK** in step 3, press **WEEKLY** (**NUMBER** key "9") for weekly serials or **DAILY** (**NUMBER** key "8") for daily serials (Monday – Friday). Either "WEEKLY" or "DAILY" appears on the screen. Pressing the button again makes the corresponding indication disappear.
- You can programme this recorder to timer-record as many as 8 programmes. If you try to programme the recorder to record a ninth, "PROGRAM FULL" appears on screen. To record the extra programme, you must first cancel any unnecessary programmes (see pg. 30).
- It is not possible to timer-record a TV programme with a G-CODE number which starts with "0".

Satellite Tuner Users

To timer-record a satellite broadcast using the G-code system:

- 1 Perform steps 1 – 6.
- 2 Set the satellite tuner to the appropriate channel before the selected programme begins.
- 3 Leave the satellite tuner's power on.

ATTENTION

Regarding Guide Program Number Set

"G-CODE SET-UP" appears after performing step 3 if the Guide Program number for the G-CODE number you entered has not been set.

- Press the **NUMBER** keys or **PUSH JOG** $\Delta \nabla$ to input the channel position number on which your recorder receives that station, then press **OK** or **PUSH JOG** \triangleright . The G-CODE program screen appears.

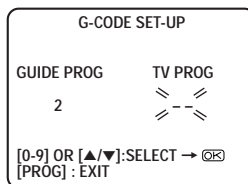

(Ex.) To timer-record a RTR programme with the G-code system.

* If your recorder receives RTR on the channel position 2, press **OK** or **PUSH JOG** \triangleright after entering "2".

Express Timer Programming

Remember, the clock must be set before you can programme the timer (☞ pg. 12).

Before performing the following steps:

- Insert a cassette with the safety tab in place. The recorder will come on automatically.
- Turn on the TV and select the VIDEO channel (or AV mode).
- Select the appropriate colour system by pressing the **COLOUR SYSTEM** button (☞ pg. 40).

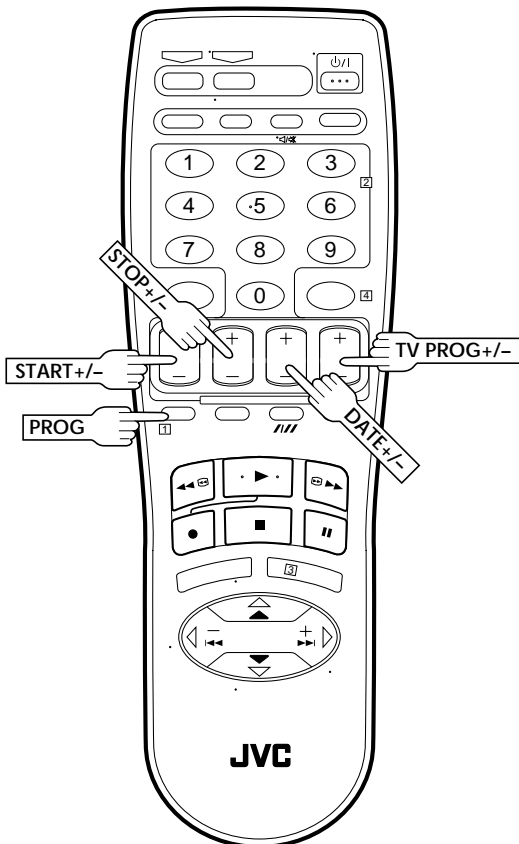
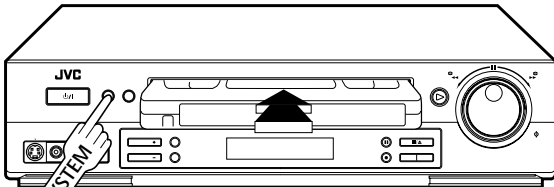

1

ACCESS G-CODE SCREEN

Press **PROG**.

2

ACCESS PROGRAMME SCREEN

Press **START +/-**. (If you're just starting out, "P1" appears.)

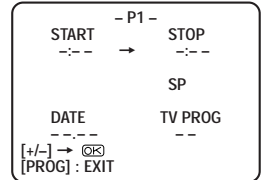

3

ENTER PROGRAMME START TIME

Press **START +/-** to enter the time you want recording to start.

- Press and hold **START +/-** to move in 30-minute increments, or press and release repeatedly to move 1 minute at a time.

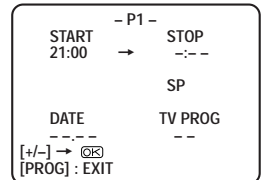

4

ENTER PROGRAMME STOP TIME

Press **STOP +/-** to enter the time you want recording to stop.

- Press and hold **STOP +/-** to move in 30-minute increments, or press and release repeatedly to move 1 minute at a time.

5

ENTER PROGRAMME DATE

Press **DATE +/-**. (The current date appears on screen. The date you enter appears in its place.)

6

ENTER CHANNEL POSITION

Press **TV PROG +/-**.

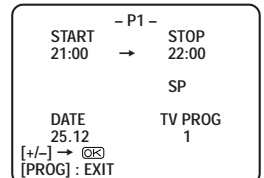

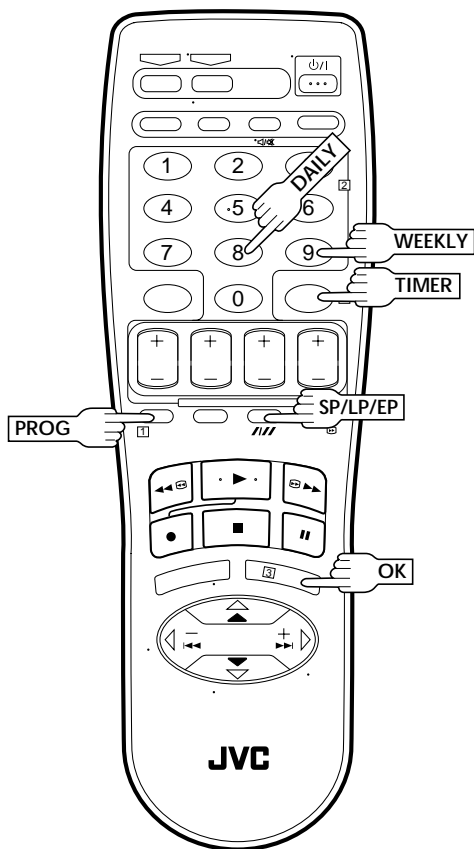

7

SET TAPE SPEED

Press **SP/LP/EP** (//) to set the tape speed.

8

RETURN TO NORMAL SCREEN

After confirming all information is correct, press **PROG** or **OK**. "PROGRAM COMPLETED" appears on the screen for about 5 seconds, then normal screen appears.

- Repeat steps 1 – 8 for each additional programme.

9

ENGAGE RECORDER'S TIMER MODE

Press **TIMER**. The recorder turns off automatically and "D" appears on the display panel.

- To disengage the timer, press **TIMER** again.

NOTES:

- To Timer-Record Weekly Or Daily Serials . . .
 . . . anytime during steps 2 through 8, press **WEEKLY** (**NUMBER** key "9") for weekly serials or **DAILY** (**NUMBER** key "8") for daily serials (Monday–Friday). Either "WEEKLY" or "DAILY" appears on the screen. Pressing the button again makes the corresponding indication disappear.
- You can programme this recorder to timer-record as many as 8 programmes. If you try to programme the recorder to record a ninth, "PROGRAM FULL" appears on screen. To record the extra programme, you must first cancel any unnecessary programmes (pg. 30).

Check, Cancel And Replace Programmes

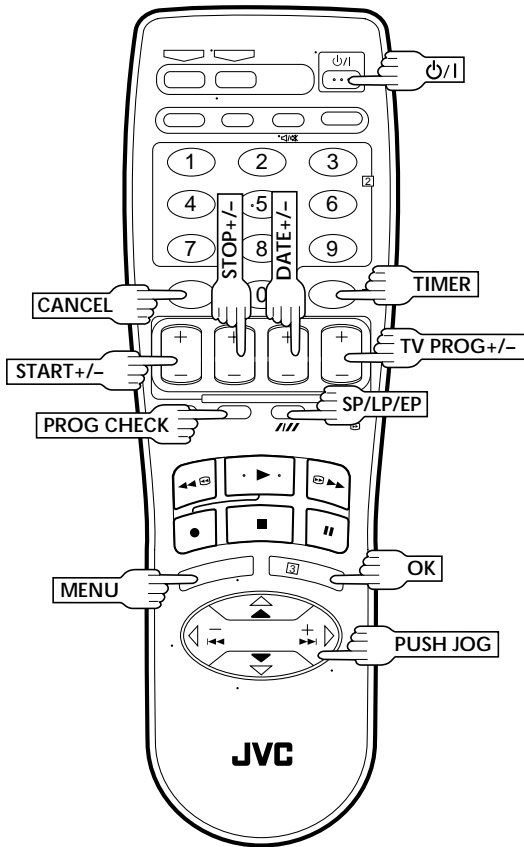

1 DISENGAGE TIMER MODE

Press **TIMER**, then press **POWER**.

2 ACCESS PROGRAMME CHECK SCREEN

Press **PROG CHECK**.

PR	START	STOP	CH	DATE
1	8:00	10:00	3	24.12
2	10:00	10:45	2	25.12
3	11:30	13:00	1	25.12
4				
5				
6				
7				
8				

[PROG CHECK] : NEXT

3 ACCESS PROGRAMME SCREEN

Press **PROG CHECK** again to check more information. Each time you press **PROG CHECK**, the next programme's information appears.

- P1 -	
START 8:00	STOP 10:00
SP	
DATE 24:12	TV PROG 3

[PROG CHECK] : NEXT

To cancel or replace a programme...

4 CANCEL OR REPLACE A PROGRAMME

Press **CANCEL** to cancel a programme. To replace a programme, press the appropriate button: **START+/-**, **STOP+/-**, **DATE+/-**, **TV PROG+/-**, **SP/LP/EP (||||)**.

5 RETURN TO NORMAL SCREEN

Press **PROG CHECK** as many times as necessary. If there are still some programmes remaining, go on to step 6.

6 RETURN TO TIMER MODE

Press **TIMER**.

Auto SP→LP Timer

If, when timer-recording in SP mode, there is not enough tape to record the entire programme, the recorder automatically switches to LP mode (with PAL broadcasts) or EP mode (with NTSC broadcasts) to allow complete recording.

For Example . . .

Recording a PAL-broadcast programme of 210 minutes in length onto a 180-minute tape.

Approximately 150 minutes Approximately 60 minutes

SP mode	LP mode
Total 210 minutes	

Make sure you set "AUTO SP→LP TIMER" to "ON" at the Function Set screen before the timer-recording starts.

1 ACCESS MAIN MENU SCREEN

Press **MENU**.

2 ACCESS FUNCTION SET SCREEN

Press **PUSH JOG** $\Delta \nabla$ to place the pointer next to "FUNCTION SET", then press **OK** or **PUSH JOG** \triangleright .

3 SELECT MODE

Press **PUSH JOG** $\Delta \nabla$ to place the pointer next to "AUTO SP→LP TIMER", then press **OK** or **PUSH JOG** \triangleright to select "ON".

FUNCTION SET	
AUTO TIMER	OFF
O.S.D.	ON
B. E. S. T.	ON
\square AUTO SP→LP TIMER	ON
S-VHS	ON
EDIT	OFF
[$\blacktriangle/\blacktriangledown$] → \square [MENU]: EXIT	

4 RETURN TO NORMAL SCREEN

Press **MENU**.

NOTES:

- If you have programmed the recorder to timer-record 2 or more programmes, the second programme and those thereafter may not fit on the tape if you set "AUTO SP→LP TIMER" to "ON". In this case, make sure the mode is not engaged, then set the tape speed manually during timer programming.
- In order to ensure that the recording fits on the tape, this feature may leave a slight non-recorded section at the end of the tape.
- There may be some noise and sound disturbance at the point on the tape where the recorder switches from SP to LP (or EP) mode.
- The Auto SP→LP Timer feature is not available during ITR (Instant Timer Recording), and the feature will not work properly with any tapes longer than E-180 or with some tapes of shorter lengths.

Auto Timer

When the Auto Timer is set to ON the timer is automatically engaged when the recorder power is turned off and automatically disengaged when the recorder is powered back on.

1 ACCESS MAIN MENU SCREEN

Press **MENU**.

2 ACCESS FUNCTION SET SCREEN

Press **PUSH JOG** $\Delta \nabla$ to place the pointer next to "FUNCTION SET", then press **OK** or **PUSH JOG** \triangleright .

MAIN MENU	
\square FUNCTION SET	
TUNER SET	
INITIAL SET	
[$\blacktriangle/\blacktriangledown$] → \square [MENU]: EXIT	

3 SELECT MODE

Press **PUSH JOG** $\Delta \nabla$ to place the pointer next to "AUTO TIMER", then press **OK** or **PUSH JOG** \triangleright to select either "ON" or "OFF".

FUNCTION SET	
\square AUTO TIMER	ON
O.S.D.	ON
B. E. S. T.	ON
AUTO SP→LP TIMER	OFF
S-VHS	ON
EDIT	OFF
[$\blacktriangle/\blacktriangledown$] → \square [MENU]: EXIT	

4 RETURN TO NORMAL SCREEN

Press **MENU**.

NOTE:

For safety, when Auto timer is set to "OFF", all other recorder functions are disabled while the Timer mode is engaged. To disengage the timer, press **TIMER**.

Remote Control Functions

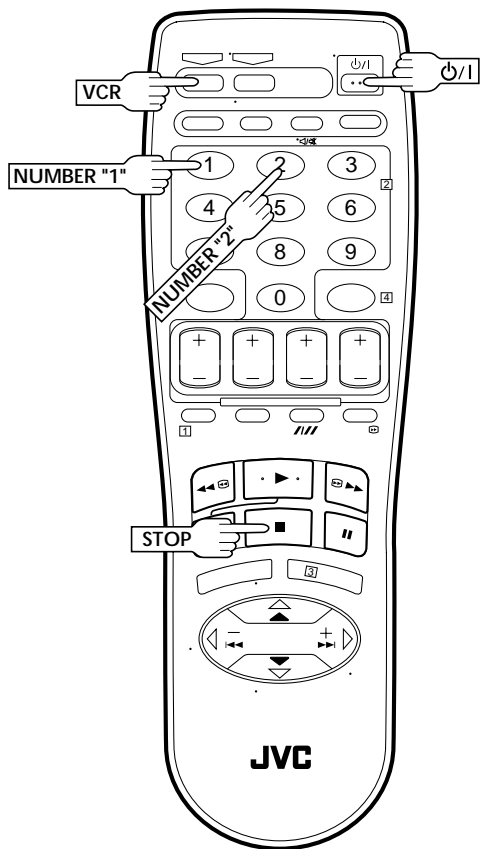

Remote A/B Code Switching

The remote control is capable of controlling two JVC video recorders independently; one set to respond to the remote control's A code control signals and another set to respond to B code control signals. The remote control is preset to send A code signals because your video recorder is initially set to respond to A code signals. You can easily modify your video recorder to respond to B code signals.

1 REMOVE POWER SUPPLY

Unplug the mains power cord from the mains outlet.

2 SET REMOTE CONTROL CODE

While holding down **VCR** on the remote control, press the **NUMBER** key "2" and then press **STOP**.

3 RE-SUPPLY POWER

Plug the mains power cord back into the mains outlet.

4 TURN THE RECORDER ON

Press ϕ/I on the remote control. The recorder will now only respond to B code signals.

NOTE:

To set the recorder back to respond to A code signals, repeat the same procedure as shown above except pressing **NUMBER** key "1" instead of "2" in step 2.

TV Multi-brand Remote Control

Your remote control can operate the basic functions of your TV set. In addition to JVC TVs, other manufacturer's TVs can also be controlled.

Before you start . . .

- Turn on the TV using its remote control.

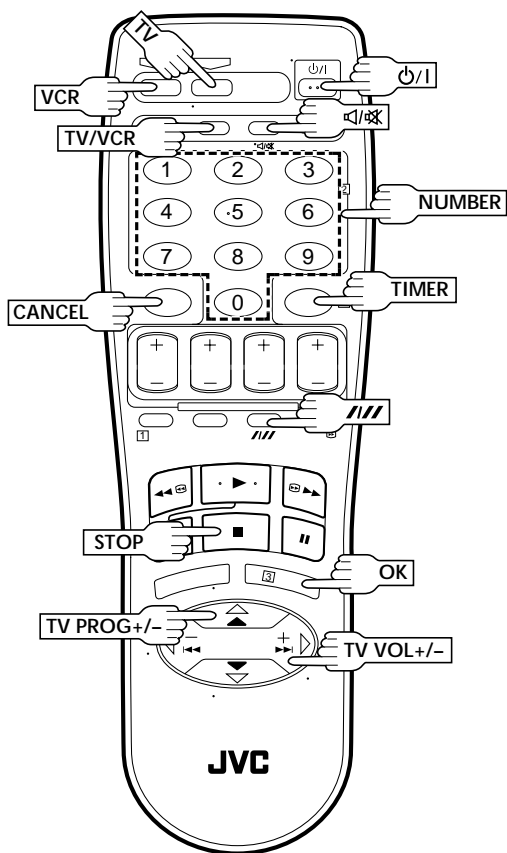

1 SET TV BRAND CODE

Refer to the chart below. While holding down **TV** on the recorder's remote control, enter your TV's brand code using the **NUMBER** keys, then press **STOP**. Check if the TV's power goes off as it should. If it does, try other operations (→ step 2).

- Once you have set the remote control to operate the TV, you don't have to repeat this step until you replace your remote control's batteries.
- Some TV brands have more than one code. If the TV does not function with one code, try entering another.

2 OPERATE TV

First, press **TV** to set the remote control to TV mode, then press the corresponding button: **TV**, **TV PROG +/-**, **TV VOL +/-** (Volume), **Muting**, **NUMBER** keys.

- For some brands of TV, you must press **OK** after having pressed the **NUMBER** keys.

IMPORTANT

Although the provided remote control unit is compatible with JVC televisions, as well as many other models, it may not work with your TV, or in some instances, may have limited function capability.

ATTENTION

The remote control can operate not only the video recorder but also some of your TV's functions.

- To operate your video recorder, first press the **VCR** button to set the remote control to the Video mode.
- To operate your TV, first press the **TV** button to set the remote control to the TV mode.

Control Your TV Using Additional Buttons

Use the **NUMBER** keys, and the **///** button, **CANCEL** button or **TIMER** button to select the TV's channel.

- With televisions under Code 01, 02, 03, 05, 07, 15, 16, 22, 23, 26 or 27, the **///** button corresponds to the 1-digit/2-digit entry switching button (often labelled - / -) of your TV's remote control.
- With televisions under Code 01, 08, 18, 19, 24 or 25, the **CANCEL** button corresponds to the 10 + button, and the **TIMER** button corresponds to the 20 + button of your TV's remote control.

NOTE:

The way these buttons are used is determined by your TV. Use these buttons as instructed for your TV's remote control.

TV BRAND NAME	CODE
JVC	01
AIWA	10
BEIJING	05, 27
CHANGHONG	05, 06, 16, 25
DAEWOO	11
FERGUSON	15
FINLUX	20
FUNAI	09
GRUNDIG	17
HITACHI	07
ITT	18
JINXING	23
KONKA	26
LG/GOLDSTAR	13
MITSUBISHI	06
MIVER	19
NEC	22
NOBLEX	27
NOKIA	21
PANASONIC	02
PEONY	23, 24, 25
PHILICO	07
PHILIPS	16
SAMSUNG	12, 16
SANYO	08
SHARP	04
SONY	03
TCL	16, 28
THOMSON	14
TOSHIBA	05

Connecting/ Using A Stereo System

These instructions enable you to connect your video recorder to your Hi-Fi stereo system (if you have one) and listen to the soundtrack through the stereo.

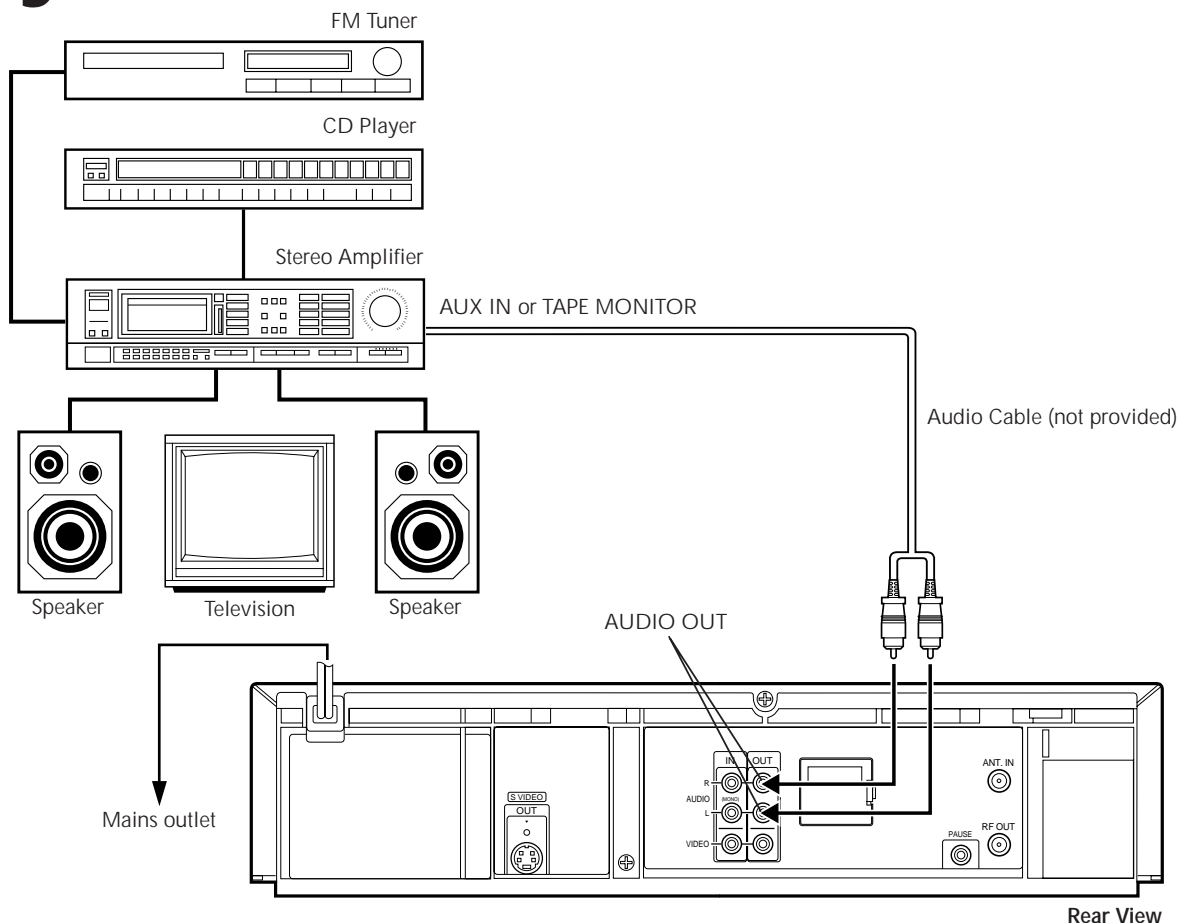

1 MAKE CONNECTIONS

Connect the AUDIO OUT L and R connectors on your video recorder to the AUX IN or TAPE MONITOR terminals on your stereo system's receiver or amplifier.

NOTES:

- When connecting your recorder's audio output connectors to a stereo amplifier, make sure you connect L and R correctly.
- If stereo or bilingual TV broadcasts are receivable in your area, this recorder can record them independently of the TV set and play them back through the connected stereo system.
- When listening to sound through the connected stereo system, turn the TV's volume down completely.

CAUTIONS:

- This recorder has a dynamic range of more than 80 dB with regards to its Hi-Fi audio capability. It is recommended that you check the maximum level if you are going to listen to the Hi-Fi audio signals through a stereo amplifier. A sudden surge in the input level to the speakers may damage them.
- Some speakers and televisions are specially shielded to prevent television interference. If both are of the non-shielded type, do not place the speakers adjacent to the TV set as this can adversely affect the video playback picture.

Preparation For Editing

Turn on the TV and select the VIDEO channel (or AV mode).

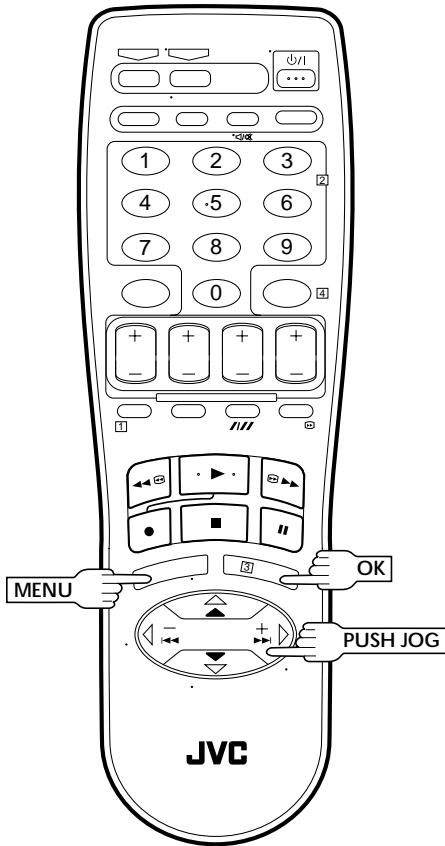

Editing Mode Setting

You can minimize picture degradation while editing.

1

ACCESS MAIN MENU SCREEN

Press **MENU**.

2

ACCESS FUNCTION SET SCREEN

Press **PUSH JOG** $\Delta \nabla$ to place the pointer next to "FUNCTION SET", then press **OK** or **PUSH JOG** \triangleright .

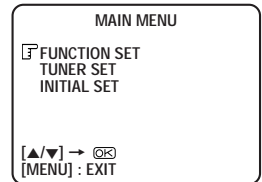

3

SELECT EDIT MODE

Press **PUSH JOG** $\Delta \nabla$ to place the pointer next to "EDIT", then press **OK** or **PUSH JOG** \triangleright to select "ON".

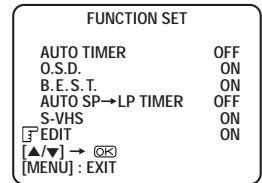

4

RETURN TO NORMAL SCREEN

Press **MENU**.

NOTE:

After you finish editing, be sure to set "EDIT" back to "OFF".

Advantages Of S-VHS Video Recorders

- You can edit from VHS to S-VHS, from S-VHS to VHS, or from S-VHS to S-VHS.
- From VHS to S-VHS: Record VHS playback signals in the S-VHS mode. Although the picture quality is inherently limited by that of the original, the edited tape has better picture quality than those made by VHS-to-VHS editing.
 - From S-VHS to VHS: Because the picture quality of the source material is very high, the edited tape has better picture quality than those made by VHS-to-VHS editing.
 - From S-VHS to S-VHS: All signals will be transferred without degradation.

Edit From A Camcorder

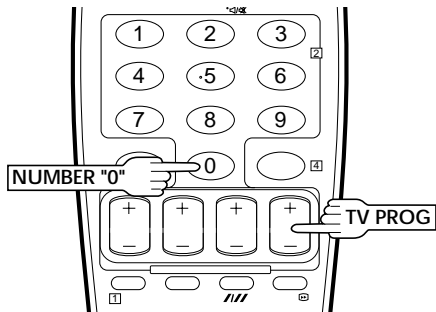

NOTES:

- All necessary cables can be obtained from your dealer.
- You can also use another video recorder as the player instead of a camcorder.

IMPORTANT:

- To edit, both the player and the recorder must be of the same colour system. Press your recorder's **COLOUR SYSTEM** button to select the appropriate colour system.
- PAL, SECAM and NTSC camcorders can be used as a player for editing.
- For more information on multi-system compatibility, see pg. 40.

You can use a camcorder as the source player and your video recorder as the recorder.

1 MAKE CONNECTIONS

- A** If the camcorder has no S-VIDEO output connector... connect the camcorder's AUDIO/VIDEO OUT connectors to the recorder's front panel AUDIO/VIDEO input connectors.
- B** If the camcorder has an S-VIDEO output connector... connect the camcorder's S-VIDEO OUT and AUDIO OUT connectors to the recorder's front panel S-VIDEO and AUDIO input connectors.

- When using a monaural camcorder, connect its AUDIO OUT connector to the AUDIO L input connector on your recorder.
- When a Master Edit Control-equipped JVC camcorder is used, the camcorder is capable of controlling the recorder. Refer to the camcorder's instruction manual for operating procedure.

2 SET RECORDER'S INPUT MODE

Press **NUMBER** key "0" and/or **TV PROG** to select "F-1" for the AUDIO/VIDEO input connectors, or "S-1" for the AUDIO/S-VIDEO input connectors, depending on the connectors being used.

3 SET EDIT MODE

See "Editing Mode Setting" on page 35.

4 START CAMCORDER

Engage its Play mode.

5 START RECORDER

Engage its Record mode.

A If the camcorder has no S-VIDEO output connector...

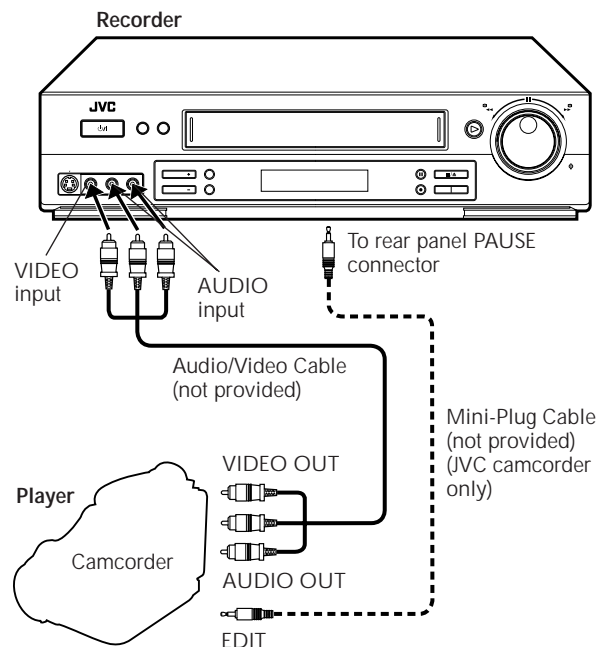

B If the camcorder has an S-VIDEO output connector...

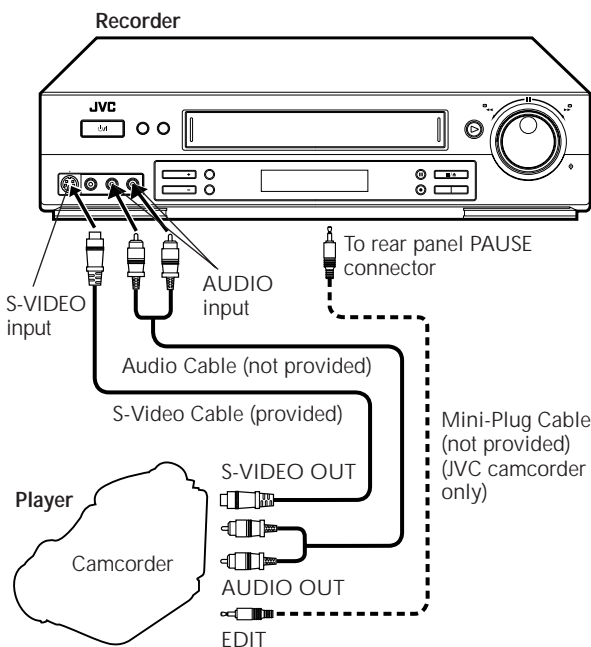

Edit To Or From Another Video Recorder

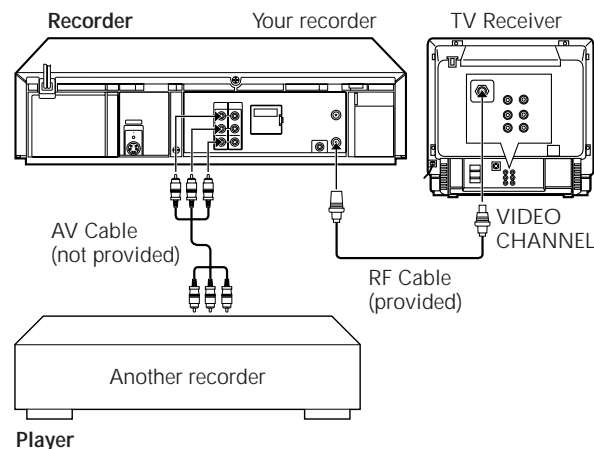
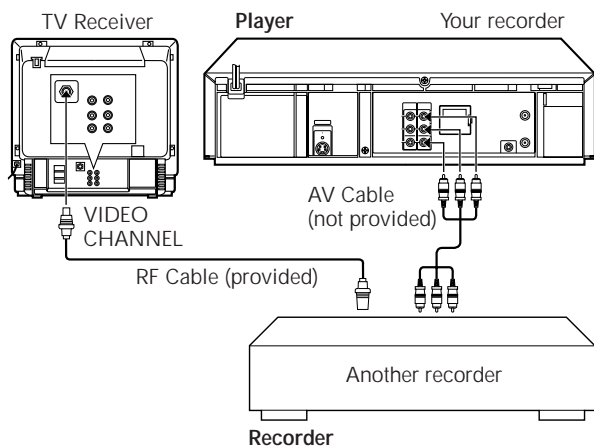

You can use your video recorder as the source player or the recording deck.

1

MAKE CONNECTIONS

Connect the player's AUDIO/VIDEO OUT connector to the recorder's AUDIO/VIDEO IN connector.

- Use the L connector for monaural connection.

2

SET RECORDING DECK'S INPUT MODE

Set to AUX. With this video recorder, press **NUMBER** key "0" and/or **TV PROG** to select depending on the connector being used — "L-1" for the rear panel VIDEO/AUDIO input connectors, or "F-1" for the front panel VIDEO/AUDIO input connectors.

3

SET EDIT MODE

See "Editing Mode Setting" on page 35.

4

START SOURCE PLAYER

Engage its Play mode.

5

START RECORDING DECK

Engage its Record mode.

NOTES:

- When you use this recorder as the player for editing, be sure to set "O.S.D." to "OFF" before starting (☞ pg. 10).
- All necessary cables can be obtained from your dealer.
- NTSC tapes being played back in the NTSC → PAL mode (☞ pg. 41) cannot be dubbed to another recorder.
- When you dub an NTSC tape using your recorder as the playback deck, select NTSC 3.58 (or NTSC 4.43) with the **COLOUR SYSTEM** button (☞ pg. 40).
- If you are using another recorder with S-Video and Audio input/output connectors, you can connect those connectors to this recorder's S-VIDEO IN/S VIDEO OUT and AUDIO IN/OUT connectors.

When Using Your Video Recorder As The Source Player ...
... connect its rear panel S VIDEO OUT and AUDIO OUT connectors to the recording deck's S-Video and Audio input connectors.

When Using Your Video Recorder As The Recording Deck ...
... connect its front panel S-VIDEO and AUDIO input connectors to the source player's S-Video and Audio output connectors. Then, set the recorder's input mode to "S-1".

IMPORTANT:

- To edit, both the player and the recorder must be of the same colour system. Press your recorder's **COLOUR SYSTEM** button to select the appropriate colour system.
- For more information on multi-system compatibility, ☞ pg. 40.

Audio Dubbing

Audio dubbing replaces the normal audio sound of a previously recorded tape with a new soundtrack.

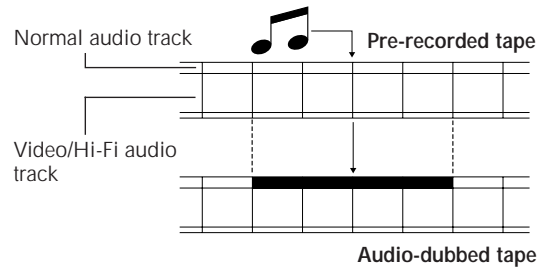

1 MAKE CONNECTIONS

Connect an audio component to the AUDIO L + R connectors on the recorder's front panel.

- When connecting monaural equipment, use only the recorder's AUDIO L connector.

2 SET INPUT MODE

Press **NUMBER** key "0" and/or **TV PROG** so that "F-1" appears in place of a channel number.

3 LOCATE START POINT

Press **PLAY** to start playback of the tape in your recorder, and press **PAUSE** when you find the point where you want to start dubbing.

4 ENGAGE AUDIO DUBBING

Press **A. DUB**.

- Your recorder enters the Audio Dubbing Pause mode. ("0" blinks, "▶" and "⏸" light up on the front display panel.)
- To perform audio dubbing with audio mixing, press **AUDIO** on the remote control to select "▶◀" (L+R) at this point.

* Audio dubbing with audio mixing is not possible if you're using a monaural audio component, or if you don't have an audio mixer.

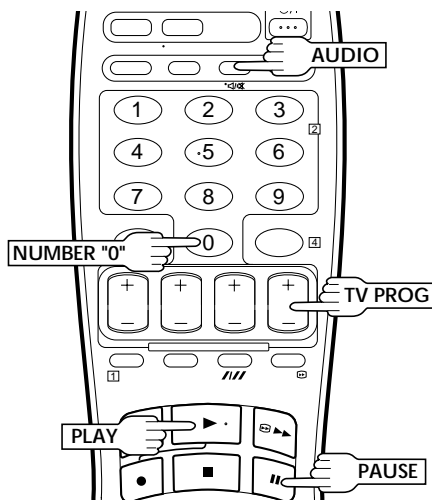
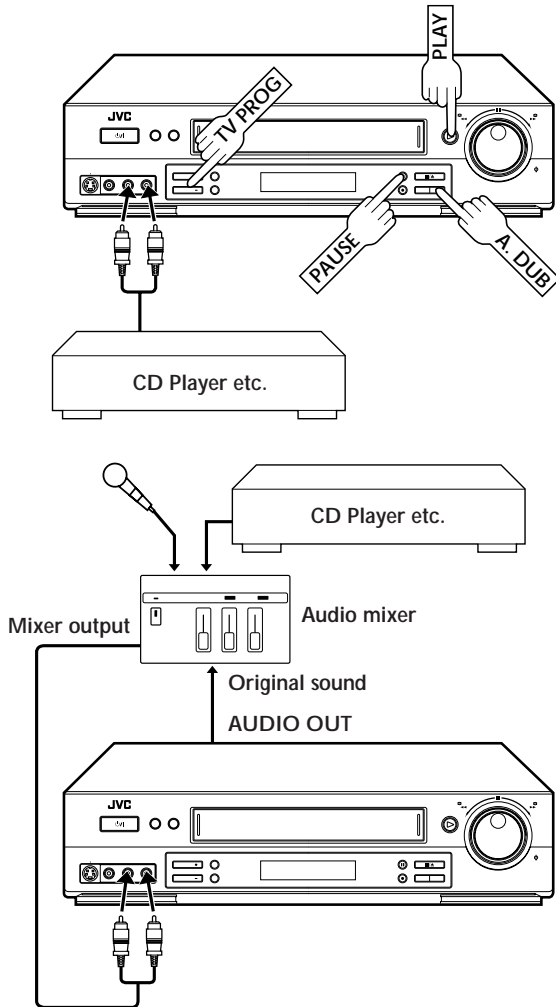

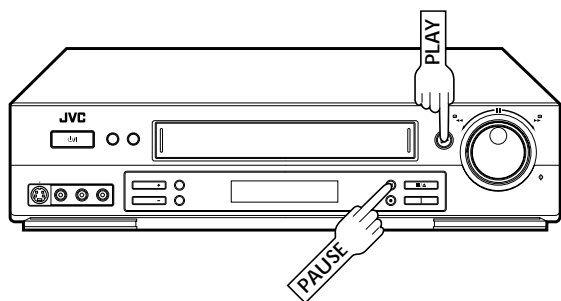

5

START DUBBING

Engage the audio component's Play mode, then press **PLAY** to start the tape in your recorder. Audio dubbing begins at this point.

- "0" blinks and "▶" is displayed on the front display panel.
- To stop dubbing temporarily, press **PAUSE**. Press **PLAY** to resume dubbing.

6

END AUDIO DUBBING

Press **STOP** to stop the tape in your recorder, and engage the audio component's Stop mode.

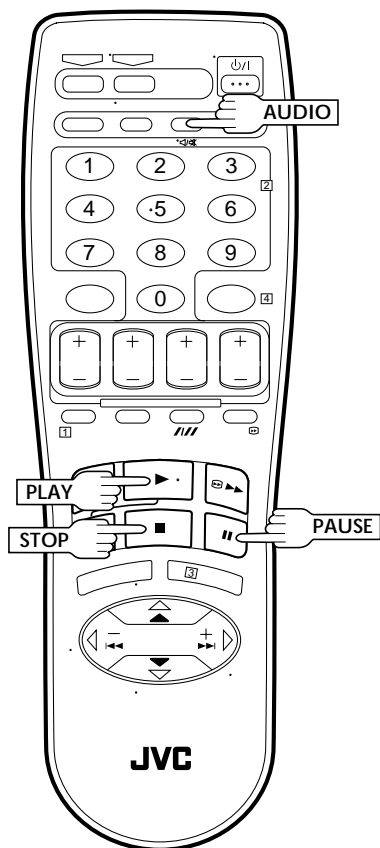

NOTES:

- When monitoring the sound during Audio Dubbing, the normal soundtrack is automatically selected. If you wish to hear the mixed sound (Hi-Fi + Normal soundtracks), press **AUDIO** on the remote control to select "NORM" (HI FI + NORM) (pg. 16).
- Audio dubbing stops automatically when the counter reaches "0:00:00", and the recorder enters the Play mode. Check the counter reading before dubbing.
- Audio dubbing is also possible using the rear panel **AUDIO IN L + R** connectors. When using these connectors, make sure to select the correct input mode in step 2.
- Audio dubbing cannot be performed on a cassette that has had its record safety tab removed.
- When playing back an audio-dubbed tape, press **AUDIO** on the remote control to select the soundtrack you wish to hear (pg. 16).

Setting Of The Colour System Select Buttons

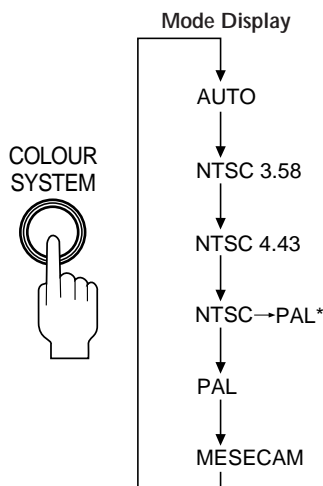

Use the **COLOUR SYSTEM** button on the front panel to select the colour system. Pressing this button changes the mode as illustrated on the left. The On-Screen display will show which mode is selected.

Mode	Description
AUTO	Usually set to this mode. This mode automatically detects PAL, NTSC, SECAM or MESECAM and adjusts to the colour system being recorded or played back. When it does not perform properly, set the colour system manually.
MANUAL	For recording, there is a choice of 4 selectable modes; PAL/MESECAM/NTSC 3.58/NTSC4.43. Select the mode that matches the colour signal being received. For playback, there is an additional mode which allows NTSC tapes to be played back and viewed on PAL TVs.

* "NTSC→PAL" appears during playback only.

NOTES:

- In the **AUTO** mode, NTSC signals will be automatically recorded as NTSC 3.58.
- In the **AUTO** mode, NTSC tapes will be played back as NTSC 3.58.
- SECAM signals will always be recorded as MESECAM. Select the **AUTO** or the **MESECAM** mode when recording SECAM signals.
- When playing back a SECAM tape, select the **AUTO** or **MESECAM** mode. The playback picture will always be monochrome.
- In the **NTSC4.43** mode, with some TVs, on-screen displays (Programme screen etc.) may roll up or down and there may be a loss of colour. When this happens, select the **AUTO** mode.

Off-Air Recording

The built-in multi-system tuner is capable of receiving PAL B/G, I, D/K, and SECAM B/G and D/K and NTSC broadcasts.

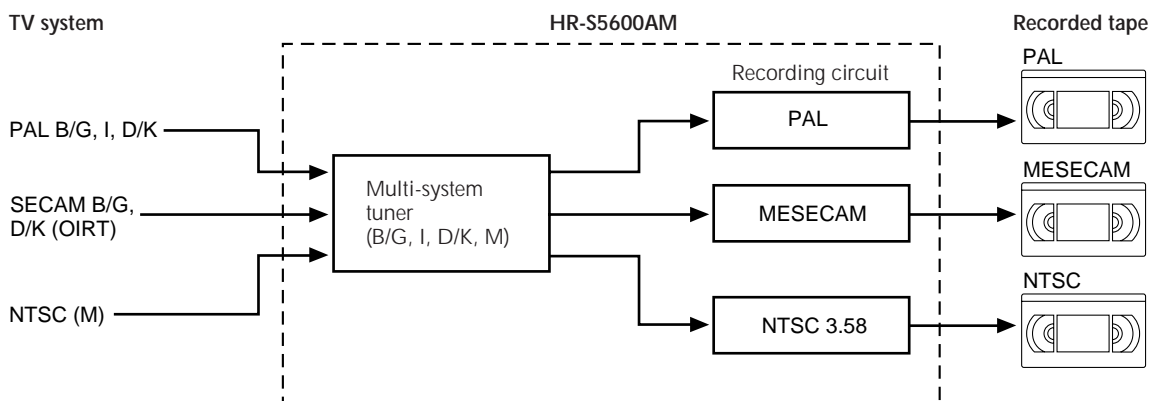

NOTE:

This model does not operate in BRAZIL (PAL-M) or ARGENTINA (PAL-N).

Playback

This recorder can play back all 3 types of recorded tape.

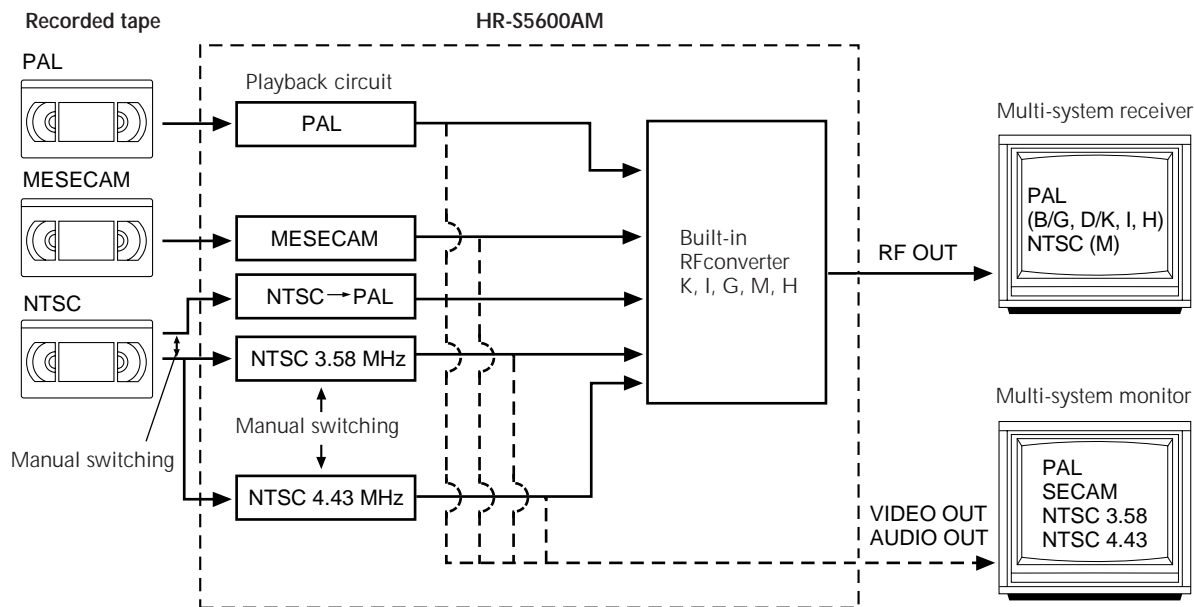

NOTES:

When viewing NTSC tapes on a PAL TV set:

- The picture may shrink vertically with black bars appearing at the top and bottom of the screen. This is not a malfunction on the part of the video recorder nor the TV.
- The picture may roll up or down. This can be corrected using the V-HOLD control found on some TVs. (This cannot be corrected if the TV does not have a V-HOLD control.)
- During search, still, or frame-by-frame playback, the picture will be distorted, and there may be a loss of colour.

ATTENTION:

When this recorder is connected to a multi-system TV, the audio signal may not be heard or may be noisy if the colour system select switch of the TV is adjusted to the AUTO position. In such a case, set the TV's colour system select switch to the appropriate position which corresponds to the TV system you have selected at the TV System Select screen.

Tape-To-Tape Editing

There are 4 different types of recorded tape, depending on the signal recorded.

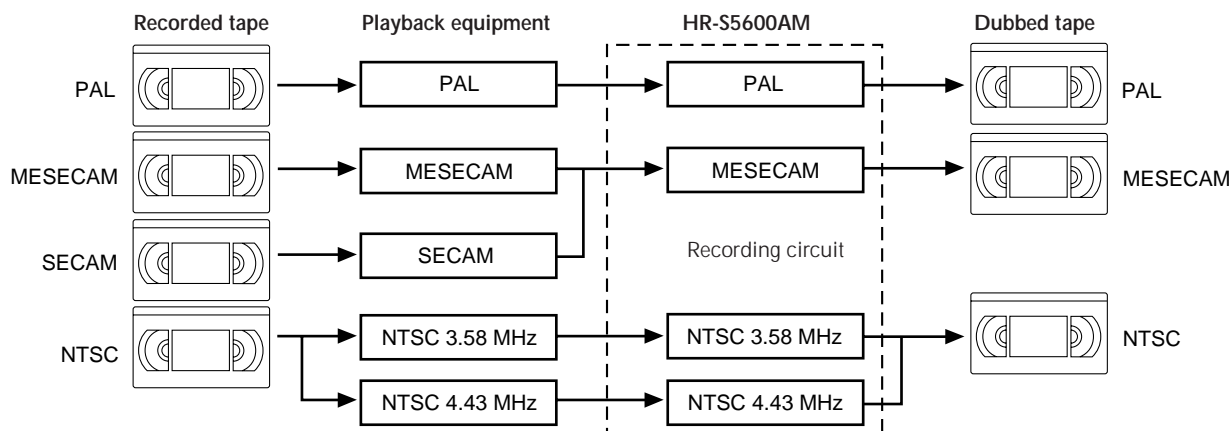

Turn on the TV and select the VIDEO channel (or AV mode).

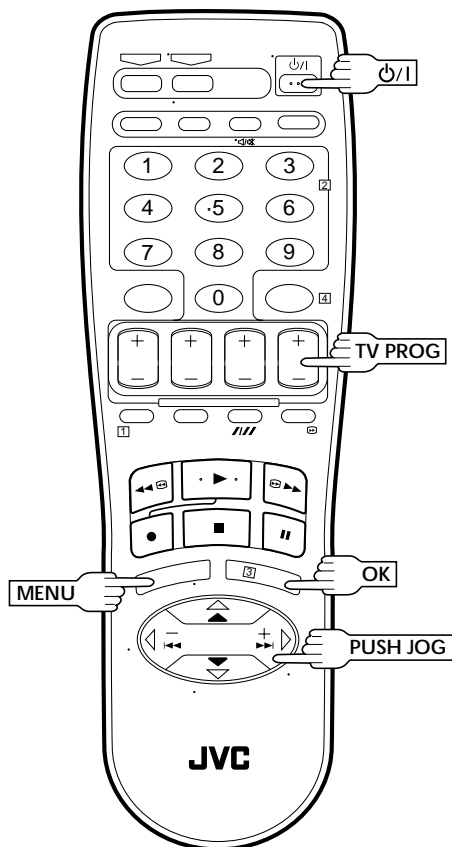

IMPORTANT

Perform the following steps only if auto channel set has not been set correctly by Auto Set Up function (pg. 8) or if you have moved to a different area or if a new station starts broadcasting in your area.

Your recorder needs to memorise all necessary stations in channel positions in order to record TV programmes. Auto Channel Set automatically assigns all receivable stations in your area so that you can call them up with the **TV PROG** buttons without going through any vacant channels.

Auto Channel Set

1 TURN ON THE RECORDER

Press **Power/1**.

2 ACCESS MAIN MENU SCREEN

Press **MENU**.

3 ACCESS TUNER SET SCREEN

Press **PUSH JOG** Δ / ∇ to place the pointer next to "TUNER SET", then press **OK** or **PUSH JOG** \triangleright .

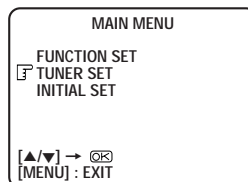

4 SELECT AUTO CH SET MODE

Press **PUSH JOG** Δ / ∇ to place the pointer next to "AUTO CH SET", then press **OK** or **PUSH JOG** \triangleright .

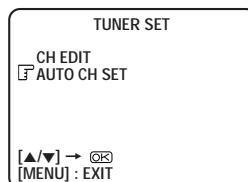

5

SELECT TV SYSTEM

Press **PUSH JOG** $\Delta\nabla$ to place the pointer next to the appropriate TV system, then press **OK** or **PUSH JOG** \triangleright .

- Auto Channel Set will start.

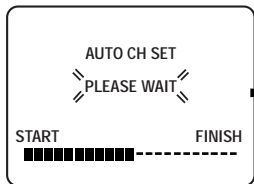
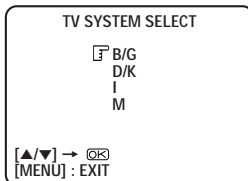

CH	FRQ	SYS	CH	FRQ	SYS
01	150	BG	07	229	BG
02	165	BG	08	237	BG
03	195	BG	09	355	BG
04	205	BG	10	365	BG
05	213	BG	11	374	BG
06	221	BG	12	384	BG

[Δ/∇] \rightarrow [CANCEL] : DELETE
[Δ/∇] \rightarrow \mathbb{OK} : EDIT
[MENU] : EXIT

6

RETURN TO NORMAL SCREEN

Press **MENU**.

NOTE:

If you perform Auto Channel Set when the aerial cable is not connected properly, "SCAN COMPLETED -NO SIGNAL-" appears on the screen in step 5. When this happens, make sure of the aerial connection and press **OK**; Auto Channel Set will take place again.

IMPORTANT

- If no sound accompanies the picture or the audio sounds unnatural on some channels that have been stored by Auto Channel Set, the TV system setting for those channels may be incorrect. Select the appropriate TV system for those channels. \mathbb{F} "TV System Selection - When you see the picture but the audio can't be heard or sounds unnatural" on page 45.
- Since your video recorder memorizes all detected stations even if the reception condition is poor, some of those stored stations may produce a noisy picture. To delete those stations, \mathbb{F} "Delete A Channel" on page 44.

Major Countries	TV System
Australia, New Zealand, Kuwait, U.A.E., Indonesia, Singapore, Thailand, Malaysia, Iran, Saudi Arabia, Egypt, Morocco, Lebanon, Iraq	B/G
China, Mongolia, Russia	D/K
Hong Kong	I
U.S.A., Japan, S.Korea, Taiwan	M

Manual Channel Set

Store channels that were not stored during Auto Set Up (\mathbb{F} pg. 8) or Auto Channel Set (\mathbb{F} pg. 42).

1

ACCESS TUNER SET SCREEN

Perform steps 1 - 3 of "Auto Channel Set" on page 42.

2

ACCESS CHANNEL LIST

Press **PUSH JOG** $\Delta\nabla$ to place the pointer next to "CH EDIT", then press **OK** or **PUSH JOG** \triangleright .

3

SELECT POSITION

Press **PUSH JOG** $\Delta\nabla$ to place the pointer next to an open channel position, then press **OK** or **PUSH JOG** \triangleright .

4

SELECT BAND

Press **PUSH JOG** $\Delta\nabla$ to place the pointer next to the band of your choice, then press **OK** to initiate Manual Channel Set.

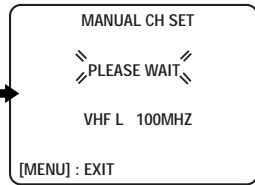
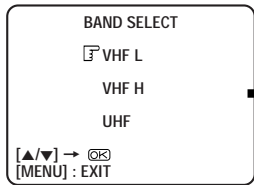

5

SET DESIRED STATION

The screen to the right appears when a station is detected.

If you do not want to store the detected station...

Press **PUSH JOG** $\Delta\nabla$ to place the pointer next to "CONTINUE", then press **OK** or **PUSH JOG** \triangleright .

Channel search will resume.

If you want to store the detected station...

Press **PUSH JOG** $\Delta\nabla$ to place the pointer next to "STORE", then press **OK** or **PUSH JOG** \triangleright . The Channel List appears again.

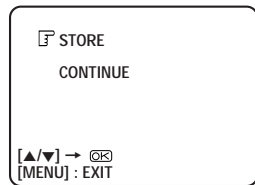

- The blueback screen and the TV picture currently being broadcast appear alternately for 8 seconds each.
- If you want to store another channel, repeat steps 3 - 5.
- When channel search completes for that band, the Band Select screen appears again. To set channels for other bands, select another band and start Manual Channel Set again (\mathbb{F} step 4 and 5).
- For fine tuning adjustment, see "Fine-Tuning Channels" on page 45.

6

RETURN TO NORMAL SCREEN

Press **MENU**.

Delete A Channel

1 ACCESS TUNER SET SCREEN

Perform steps 1 – 3 of "Auto Channel Set" on page 42.

2 ACCESS CHANNEL LIST

Press **PUSH JOG** Δ/∇ to place the pointer next to "CH EDIT", then press **OK** or **PUSH JOG** \triangleright .

3 SELECT CHANNEL

Press **PUSH JOG** Δ/∇ until the channel you want to delete begins blinking.

CH	FRO	SYS	CH	FRO	SYS
01	150	BG	07	229	BG
02	165	BG	08	237	BG
03	195	BG	09	355	BG
04	205	BG	10	365	BG
05	213	BG	11	374	BG
06	221	BG	12	384	BG

[Δ/∇] \rightarrow [CANCEL]: DELETE
 [Δ/∇] \rightarrow [OK]: EDIT
 [MENU]: EXIT

4 DELETE CHANNEL

Press **CANCEL**.

- To re-store it, simply press **PUSH JOG** \triangleleft .
- Repeat steps 3 – 4 as necessary.

CH	FRO	SYS	CH	FRO	SYS
01	---	---	07	229	BG
02	165	BG	08	237	BG
03	195	BG	09	355	BG
04	205	BG	10	365	BG
05	213	BG	11	374	BG
06	221	BG	12	384	BG

[Δ/∇] \rightarrow [\triangleleft]: ADD
 [MENU]: EXIT

5 RETURN TO NORMAL SCREEN

Press **MENU**.

Swap Channel Positions

Example: To swap CH03 and CH09.

1 ACCESS TUNER SET SCREEN

Perform steps 1 – 3 of "Auto Channel Set" on page 42.

2 ACCESS CHANNEL LIST

Press **PUSH JOG** Δ/∇ to place the pointer next to "CH EDIT", then press **OK** or **PUSH JOG** \triangleright .

3 SELECT POSITION (e.g. 03)

Press **PUSH JOG** Δ/∇ until the section of CH "03" begins blinking, then press **OK** or **PUSH JOG** \triangleright .

- Only "03" will blink.

CH	FRO	SYS	CH	FRO	SYS
01	150	BG	07	229	BG
02	165	BG	08	237	BG
03	195	BG	09	355	BG
04	205	BG	10	365	BG
05	213	BG	11	374	BG
06	221	BG	12	384	BG

[0 - 9]: INPUT CH
 [OK]: FINE TUNING
 [MENU]: EXIT

4 SELECT POSITION (e.g. 09)

Press **NUMBER** keys to input "0" and "9".

- The two selected channels will be swapped.
- To cancel the channel swapping, press **PUSH JOG** \triangleleft .

CH	FRO	SYS	CH	FRO	SYS
01	150	BG	07	229	BG
02	165	BG	08	237	BG
03	355	BG	09	195	BG
04	205	BG	10	365	BG
05	213	BG	11	374	BG
06	221	BG	12	384	BG

[\triangleleft]: CANCEL
 [OK]: OK
 [MENU]: EXIT

5 STORE NEW POSITIONS

Press **OK** or **PUSH JOG** \triangleright .

- Repeat steps 3 – 5 as necessary.

6 RETURN TO NORMAL SCREEN

Press **MENU**.

Fine-Tuning Channels

1

ACCESS TUNER SET SCREEN

Perform steps 1 – 3 of "Auto Channel Set" on page 42.

2

ACCESS CHANNEL LIST

Press **PUSH JOG** Δ / ∇ to place the pointer next to "CH EDIT", then press **OK** or **PUSH JOG** \triangleright .

3

SELECT CHANNEL TO FINE-TUNE

Press **PUSH JOG** Δ / ∇ until the channel you want to tune begins blinking, then press **OK** twice.

- The "FRQ" number for that channel starts blinking.

CH	FRQ	SYS	CH	FRQ	SYS
01	150	BG	07	229	BG
02	165	BG	08	237	BG
03	195	BG	09	355	BG
04	205	BG	10	365	BG
05	213	BG	11	374	BG
06	221	BG	12	384	BG

[Δ / ∇] : FINE TUNING
 [OK] : SELECT SYSTEM
 [MENU] : EXIT

4

PERFORM TUNING

Press **PUSH JOG** Δ / ∇ until the picture becomes clearer, then press **OK** or **PUSH JOG** \triangleright .

- Repeat steps 3 and 4 as necessary.

5

RETURN TO NORMAL SCREEN

Press **MENU**.

TV System Selection – When you see the picture but the audio can't be heard or sounds unnatural

1

ACCESS TUNER SET SCREEN

Perform steps 1 – 3 of "Auto Channel Set" on page 42.

2

ACCESS CHANNEL LIST

Press **PUSH JOG** Δ / ∇ to place the pointer next to "CH EDIT", then press **OK** or **PUSH JOG** \triangleright .

3

SELECT CHANNEL

Press **PUSH JOG** Δ / ∇ until the channel you want to change its TV system begins blinking, then press **OK** three times.

- The "SYS" display for that channel starts blinking.

CH	FRQ	SYS	CH	FRQ	SYS
01	150	BG	07	229	BG
02	165	BG	08	237	BG
03	195	BG	09	355	BG
04	205	BG	10	365	BG
05	213	BG	11	374	BG
06	221	BG	12	384	BG

[Δ / ∇] : SELECT SYSTEM
 [OK] : OK
 [MENU] : EXIT

4

SELECT TV SYSTEM

Press **PUSH JOG** Δ / ∇ to select the appropriate TV system (BG \rightarrow DK \rightarrow I \rightarrow M). Then press **OK** or **PUSH JOG** \triangleright .

- Repeat steps 3 and 4 as necessary.

5

RETURN TO NORMAL SCREEN

Press **MENU**.

Before requesting service for a problem, use this chart and see if you can repair the trouble yourself. Small problems are often easily corrected, and this can save you the trouble of sending your video recorder off for repair.

POWER

SYMPTOM	POSSIBLE CAUSE	CORRECTIVE ACTION
1. No power is applied to the recorder.	<ul style="list-style-type: none"> The mains power cord is disconnected. 	Connect the mains power cord.
2. The clock is functioning properly, but the recorder cannot be powered.	<ul style="list-style-type: none"> "⊖" is displayed on the display panel with Auto Timer set to "OFF". 	Press the TIMER button to turn the "⊖" indicator off.
3. The remote control won't function.	<ul style="list-style-type: none"> The batteries are discharged. 	Replace the dead batteries with new ones.

TAPE TRANSPORT

SYMPTOM	POSSIBLE CAUSE	CORRECTIVE ACTION
1. The tape does not run during recording.	<ul style="list-style-type: none"> "⏏" is displayed on the display panel. 	Press PLAY to turn the "⏏" indicator off.
2. The tape will not rewind or fast-forward.	<ul style="list-style-type: none"> The tape is already fully rewound or fast-forwarded. 	Check the cassette.

PLAYBACK

SYMPTOM	POSSIBLE CAUSE	CORRECTIVE ACTION
1. The playback picture does not appear while the tape is running.	<ul style="list-style-type: none"> If you're using the RF OUT connection the TV receiver's channel selector is not set to the VIDEO channel. the recorder's VIDEO channel has not been correctly set. If you're using the AV or S-VIDEO connection, the TV receiver is not set to the AV mode. 	<p>If you are using the RF OUT connection set the TV receiver to the VIDEO channel. (☞ pg. 6)</p> <p>. . . Perform "Video Channel Set". (☞ pg. 6)</p> <p>If you are using the AV or S-VIDEO connection, set the TV to its AV mode.</p>
2. Noise appears during visual search.	<ul style="list-style-type: none"> This is normal. 	
3. Noise appears during normal playback.	<ul style="list-style-type: none"> The automatic tracking mode is engaged. 	Try manual tracking. (☞ pg. 15)
4. Noise appears during slow-motion playback.	<ul style="list-style-type: none"> The automatic tracking mode is engaged. 	Try manual tracking. (☞ pg. 15)
5. Noise appears during still playback.		Press TV PROG + or - a few times to remove the noise bars from the screen.
6. Breaks are noticeable in Hi-Fi soundtrack.	<ul style="list-style-type: none"> Automatic tracking is engaged. 	Engage and adjust tracking manually. (☞ pg. 15)
7. The playback picture is blurred or interrupted while TV broadcasts are clear.	<ul style="list-style-type: none"> The video heads may be dirty. 	Consult your JVC dealer.
8. Playback picture has a loss of colour.	<ul style="list-style-type: none"> The wrong colour system is selected for the tape being played back. The wrong colour system was selected during recording. 	<p>Select the correct colour system by pressing the COLOUR SYSTEM button. (☞ pg. 40)</p> <p>Once recorded, the signal cannot be corrected. Be sure to choose the correct setting before recording.</p>
9. No sound accompanies the playback picture.	<ul style="list-style-type: none"> The TV system you have selected at the TV System Select screen is incorrect. 	Set it to the correct position for the TV broadcast system used in your area. (☞ pg. 45)

RECORDING

SYMPTOM	POSSIBLE CAUSE	CORRECTIVE ACTION
1. Recording cannot be started.	<ul style="list-style-type: none"> There is no cassette loaded, or the cassette loaded has had its Record Safety tab removed. 	Insert a cassette, or using adhesive tape, reseal the slot where the tab was removed.
2. TV broadcasts cannot be recorded.	<ul style="list-style-type: none"> "L-1", "F-1" or "S-1" has been selected as the input mode. 	Set to the desired channel.
3. Tape-to-tape editing is not possible.	<ul style="list-style-type: none"> The source (another video recorder, camcorder) has not been properly connected. All necessary power switches have not been turned on. The input mode is not correct. 	<p>Confirm that the source is properly connected.</p> <p>Confirm that all units' power switches are turned on.</p> <p>Set the input mode to "L-1", "F-1" or "S-1".</p>
4. Camcorder recording is not possible.	<ul style="list-style-type: none"> The camcorder has not been properly connected. The input mode is not correct. 	<p>Confirm that the camcorder is properly connected.</p> <p>Set the input mode to "L-1", "F-1" or "S-1".</p>

TIMER RECORDING

SYMPTOM	POSSIBLE CAUSE	CORRECTIVE ACTION
1. Timer recording won't work.	<ul style="list-style-type: none"> The clock and/or the timer have been set incorrectly. The timer is not engaged. 	Re-perform the clock and/or timer settings. Press TIMER and confirm that "⊖" is displayed on the display panel.
2. On-screen timer programming is not possible.	<ul style="list-style-type: none"> Timer recording is in progress. 	Timer programming can't be performed while a timer recording is in progress. Wait until it finishes.
3. "⊖" and "⊞" on the display panel won't stop blinking.	<ul style="list-style-type: none"> The timer is engaged but there's no cassette loaded. 	Load a cassette with the Record Safety tab intact, or cover the hole using adhesive tape.
4. The cassette is automatically ejected, and "⊖" and "⊞" on the display panel won't stop blinking.	<ul style="list-style-type: none"> The loaded cassette has had its Record Safety tab removed. 	Remove the cassette and cover the hole with adhesive tape, or insert a cassette with the Record Safety tab intact.
5. "⊖" blinks for 10 seconds and the Timer mode is disengaged.	<ul style="list-style-type: none"> TIMER has been pressed when there are no programs in memory, or the timer record information has been programmed incorrectly. 	Check the programmed data and re-program as necessary, then press TIMER again.
6. The cassette is automatically ejected, the power shuts off and "⊖" and "⊞" won't stop blinking.	<ul style="list-style-type: none"> The end of the tape was reached during timer recording. 	The programme may not have been recorded in its entirety. Next time make sure you have enough time on the tape to record the entire programme.
7. The G-CODE system does not timer-record properly.	<ul style="list-style-type: none"> The recorder's channel positions have been set incorrectly. 	Refer to "G-CODE System Setup" and re-perform the procedure. (▶ pg. 24)

OTHER PROBLEMS

SYMPTOM	POSSIBLE CAUSE	CORRECTIVE ACTION
1. Whistling or howling is heard from the TV during camcorder recording.	<ul style="list-style-type: none"> ● The camcorder's microphone is too close to the TV. ● The TV's volume is too high. 	Position the camcorder so its microphone is away from the TV. Turn the TV's volume down.
2. When scanning channels, some of them are skipped over.	<ul style="list-style-type: none"> ● Those channels have been designated to be skipped. 	If you need the skipped channels, restore them. (☞ pg. 43)
3. The channel cannot be changed.	<ul style="list-style-type: none"> ● Recording is in progress. 	Press PAUSE to pause the recording, change channels, then press PLAY to resume recording.
4. Channel settings that were made manually seem to have changed or disappeared.	<ul style="list-style-type: none"> ● After the manual settings were made, Auto Channel Set was performed. 	Perform manual setting again.
5. No channels are stored in the recorder's memory.	<ul style="list-style-type: none"> ● The TV aerial cable was not connected to the recorder when Auto Set Up was performed. 	Connect the TV aerial cable to the recorder properly and turn off the recorder power once, then turn the recorder power back on again. The recorder will try Auto Set Up again. (☞ pg. 8)
6. "--:--" is displayed on the front display panel after a power outage.	<ul style="list-style-type: none"> ● The lithium battery is exhausted. 	Replace the lithium battery with a new one. (☞ pg. 7)

PLAYBACK

- Q. What happens if the end of the tape is reached during playback or search?**
A. The tape is automatically rewound to the beginning.
.....
- Q. Can the video recorder indefinitely remain in the still mode?**
A. No. It stops automatically after 5 minutes to protect the heads.
.....
- Q. When returning from multi-speed search to normal playback, the picture is disturbed. Should I be concerned about this?**
A. No, it is normal.
.....
- Q. Other than preventing further recording, what effect does removing the Record Safety tab have?**
A. It disables marking of index codes.
.....
- Q. Sometimes, during Index Search, the video recorder can't find the programme I want to see. Why not?**
A. There may be index codes too close together.
.....

RECORDING

- Q. When I pause and then resume a recording, the end of the recording before the pause is overlapped by the beginning of the continuation of recording. Why does this happen?**
A. This is normal. It reduces distortion at the pause and resume points.
.....
- Q. Can the video recorder indefinitely remain in the Record-Pause mode?**
A. No. The video recorder goes to its Stop mode automatically after 5 minutes to protect the heads.
.....
- Q. What happens if the tape runs out during recording?**
A. The video recorder automatically rewinds it to the beginning.
.....

TIMER RECORDING

- Q. "○" and "⊖" remain lit on the display panel. Is there a problem?**
A. No. This is a normal condition for a timer recording in progress.
.....
- Q. Can I program the timer while I'm watching a tape or a TV broadcast?**
A. You won't see the picture as it is replaced by the on-screen menu, but the audio from the program or tape you're viewing can be heard.
.....
- Q. Is it possible to timer-record a TV programme broadcast in 2000?**
A. Yes, it is possible.
.....

ATTENTION:

This recorder contains microcomputers. External electronic noise or interference could cause malfunctioning. In such cases, switch the recorder off and unplug the mains power cord. Then plug it in again and turn the recorder on. Take out the cassette. After checking the cassette, operate the unit as usual.

FRONT VIEW

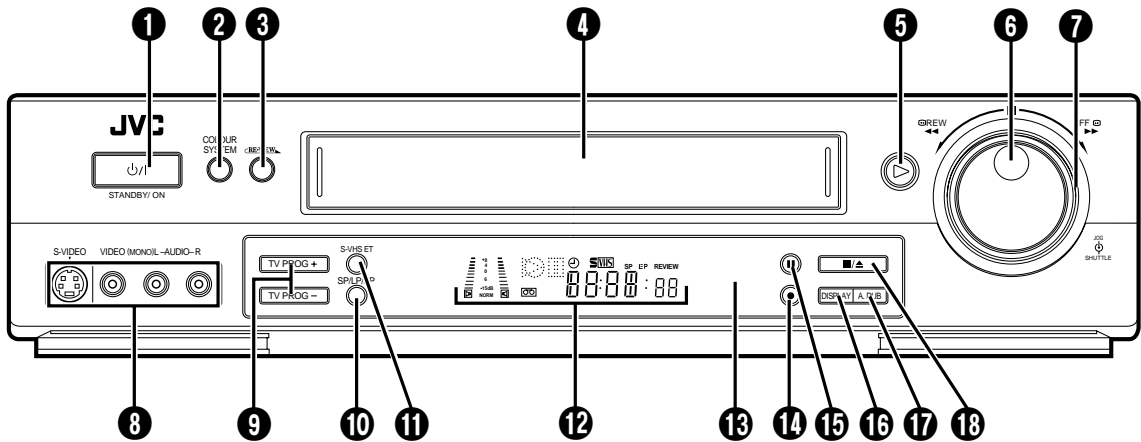

- ❶ STANDBY/ON ψ /I Button \rightarrow pg. 10
- ❷ COLOUR SYSTEM Button \rightarrow pg. 40
- ❸ REVIEW Button \rightarrow pg. 16
- ❹ Cassette Loading Slot
- ❺ PLAY Button \rightarrow pg. 13
- ❻ JOG Dial \rightarrow pg. 14
- ❼ SHUTTLE Ring \rightarrow pg. 14
- ❽ S-VIDEO/VIDEO/AUDIO Input Connectors \rightarrow pg. 36
- ❾ TV PROG +/- Buttons \rightarrow pg. 17
- ❿ SP/LP/EP Button \rightarrow pg. 17
- ⓫ S-VHS ET Button \rightarrow pg. 20
- ⓬ Display Panel \rightarrow pg. 51
- ⓭ Infrared Beam Receiving Window
- ⓮ RECORD Button \rightarrow pg. 17
- ⓯ PAUSE Button \rightarrow pg. 14
- ⓰ DISPLAY Button \rightarrow pg. 18
- ⓱ A. DUB [Audio Dubbing] Button \rightarrow pg. 38
- ⓲ STOP/EJECT Button \rightarrow pg. 13

REAR VIEW

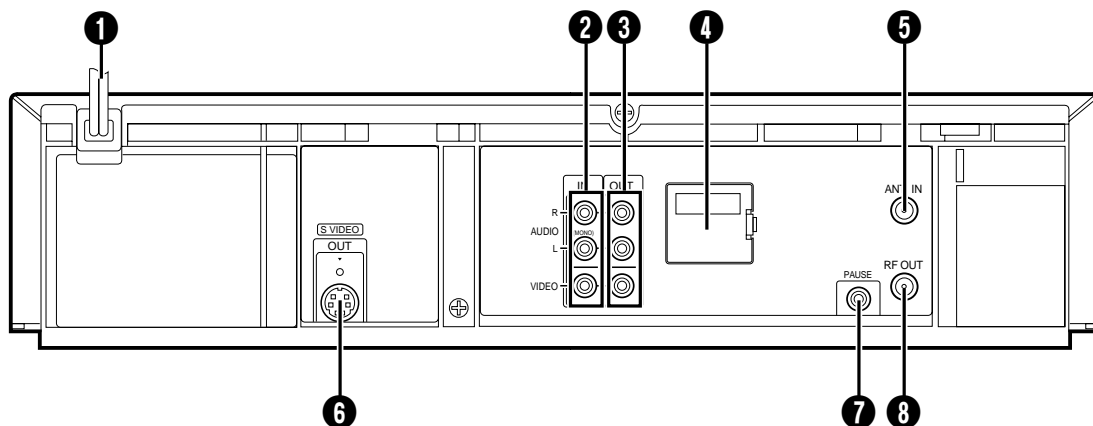

- ❶ Mains Power Cord ☞ pg. 4, 5
- ❷ AUDIO/VIDEO IN Connectors ☞ pg. 37
- ❸ AUDIO/VIDEO OUT Connectors ☞ pg. 4, 5, 37
- ❹ Lithium Battery Compartment ☞ pg. 7
- ❺ ANT. IN Connector ☞ pg. 4, 5
- ❻ S VIDEO OUT Connector ☞ pg. 5
- ❼ Remote PAUSE Connector ☞ pg. 36
- ❽ RF OUT Connector ☞ pg. 4, 5

DISPLAY PANEL

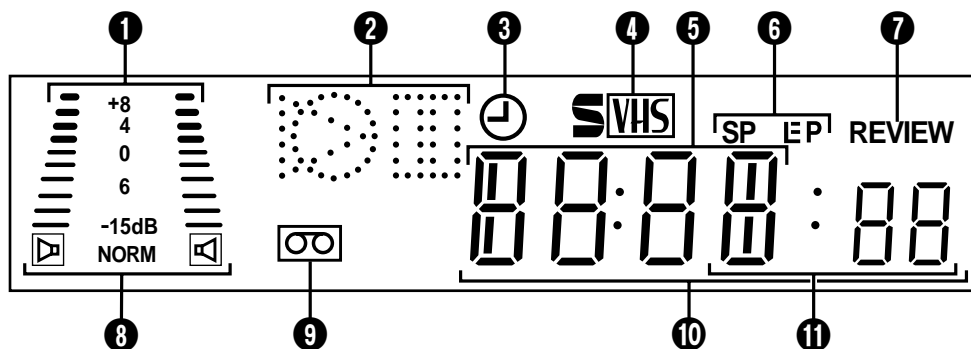

- ❶ B.E.S.T. Picture System Display ☞ pg. 22
Audio Level Indicator
- ❷ Symbolic Mode Indicators
- ❸ "Timer" Indicator ☞ pg. 27, 29
- ❹ S-VHS Indicator ☞ pg. 20
- ❺ Channel Display
Clock Display
- ❻ Tape Speed Indicators ☞ pg. 17
- ❼ Instant REVIEW Indicator ☞ pg. 16
- ❽ Audio Mode Indicator ☞ pg. 16
- ❹ "Cassette Loaded" Mark
- ❿ Counter Display
- ⓫ Mode Display (L-1, F-1 or S-1)

PLAY: FF/REW VARIABLE SHUTTLE SEARCH:		STILL: SLOW:	
AUDIO DUBBING:		RECORD:	
AUDIO DUBBING PAUSE:		RECORD PAUSE:	

REMOTE CONTROL

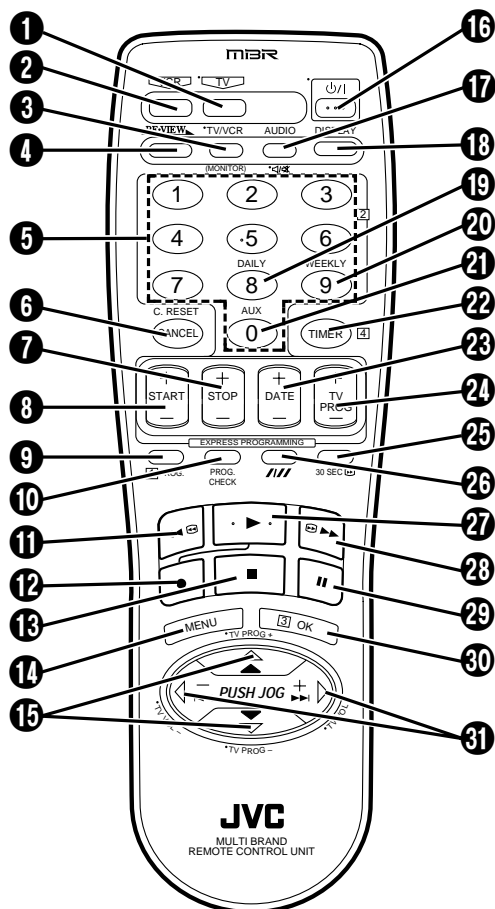

- 1 TV Button ☞ pg. 33
- 2 VCR Button ☞ pg. 33
- 3 TV/VCR Button ☞ pg. 33
- 4 REVIEW Button ☞ pg. 16
- 5 NUMBER Keys ☞ pg. 17
- 6 CANCEL Button ☞ pg. 30
- 7 STOP +/- Button ☞ pg. 28
- 8 START +/- Button ☞ pg. 28
- 9 PROG Button ☞ pg. 26, 28
- 10 PROG CHECK Button ☞ pg. 30
- 11 Rewind [REW] Button ☞ pg. 13, 14
- 12 RECORD Button ☞ pg. 17
- 13 STOP Button ☞ pg. 13
- 14 MENU Button ☞ pg. 8, 10
- 15 PUSH JOG Δ∇ Button ☞ pg. 8, 10
- 16 POWER ⏻ Button ☞ pg. 10
- 17 AUDIO Button ☞ pg. 16
- 18 (TV Muting) Button ☞ pg. 33
- 19 DISPLAY Button ☞ pg. 18
- 20 DAILY Button ☞ pg. 27, 29
- 21 WEEKLY Button ☞ pg. 27, 29
- 22 AUX Button ☞ pg. 36, 37
- 23 TIMER Button ☞ pg. 27, 29
- 24 DATE +/- Button ☞ pg. 28
- 25 TV PROG +/- Button ☞ pg. 17, 28
- 26 30 SEC Button ☞ pg. 16
- 27 Tracking Button ☞ pg. 15
- 28 SP/LP/EP Button ☞ pg. 17
- 29 PLAY Button ☞ pg. 13
- 30 Fast Forward [FF] Button ☞ pg. 13, 14
- 31 PAUSE Button ☞ pg. 14
- 32 OK Button ☞ pg. 6
- 33 PUSH JOG <D>(◀▶) Button ☞ pg. 14, 15
- 34 TV VOL +/- Button ☞ pg. 33

Buttons with a small dot on the left side of the name can also be used to operate your TV ☞ pg. 33.

How To Use

The remote control can operate most of your video recorder's functions, as well as basic functions of TV sets of JVC and other brands ☞ pg. 33.

- Point the remote control toward the sensor window.
- The maximum operating distance of the remote control is about 8 m.

NOTES:

- When inserting the batteries, be sure to insert in the correct directions as indicated under the battery cover.
- If the remote control doesn't work properly, remove its batteries, wait a short time, replace the batteries and then try again.

ATTENTION

The remote control can operate not only the video recorder but also some of your TV's functions.

- To operate your video recorder, first press the **VCR** button to set the remote control to the Video mode.
- To operate your TV, first press the **TV** button to set the remote control to the TV mode (☞ pg. 33).

GENERAL

Power requirement	
Rating	: AC 110 – 240 V~, 50/60 Hz
Operating	: AC 90 – 260 V~, 50/60 Hz
Power consumption	: 26 W
Temperature	
Operating	: 5°C to 40°C
Storage	: -20°C to 60°C
Operating position	: Horizontal only
Dimensions (WxHxD)	: 400 x 94 x 347 mm
Weight	: 4.2 kg
Format	: S-VHS/VHS standard
Maximum recording time	
(SP)	: 240 min. with E-240 video cassette (PAL/MESECAM)
	: 160 min. with T-160 video cassette (NTSC)
(LP)	: 480 min. with E-240 video cassette (PAL/MESECAM)
(EP)	: 480 min. with T-160 video cassette (NTSC)

VIDEO/AUDIO

Signal system	: PAL-type colour signal and CCIR monochrome signal, 625 lines/50 fields
	: NTSC colour and EIA monochrome signals, 525 lines/60 fields
Recording system	: DA-4 (Double Azimuth) head helical scan system
Signal-to-noise ratio	: 45 dB
Horizontal resolution	: 400 lines (S-VHS)
	: 250 lines (VHS PAL/MESECAM)
	: 220 lines (VHS NTSC)
Frequency range	: 70 Hz to 10,000 Hz (Normal audio)
	: 20 Hz to 20,000 Hz (Hi-Fi audio)
Input/Output	: RCA connectors (IN x 2, OUT x 1)
	: S-Video connectors (IN x 1, OUT x 1)

TUNER/TIMER

TV channel storage capacity	: 99 positions (+AUX position)
Tuning system	: Frequency synthesized tuner
Channel coverage	: VHF (Low) 42 – 175 MHz (High) 175 – 470 MHz
	: UHF 470 – 870 MHz
Aerial output	: UHF channels (Adjustable E28 – E60)
Memory backup time	: Approx. 6 months
	: Estimated figure based on supplied fresh battery; actual performance may differ.

ACCESSORIES

Provided accessories	: RF cable, S-Video cable, Infrared remote control unit, "R6/UM-3" battery x 2, Lithium battery CR2025, Conversion plug*
----------------------	---

*Not provided in certain areas.

Specifications shown are for SP mode unless otherwise specified.

Design and specifications subject to change without notice.

